



# Quick Start Guide

F22A

EN

DE

ES

FR

IT

NL

PT

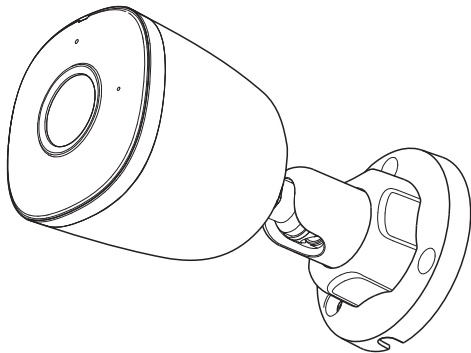

[www.imoulife.com](http://www.imoulife.com)

# Welcome

Thank you for choosing IMOJ.

We are devoted to providing you easy smart home products.

If you have problems using the product, please contact our service team before returning your product.

Our service mail: [service.global@imoulife.com](mailto:service.global@imoulife.com)

Frequently asked questions can be found at [imoulife.com/support/help](http://imoulife.com/support/help)



## Package content

EN

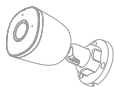

Camera x1



Positioning Map x1



Waterproof Connector x1



Screw Package x1



Quick Start Guide x1

## Camera introduction

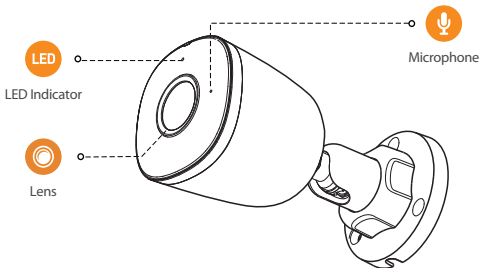

## Scene1:

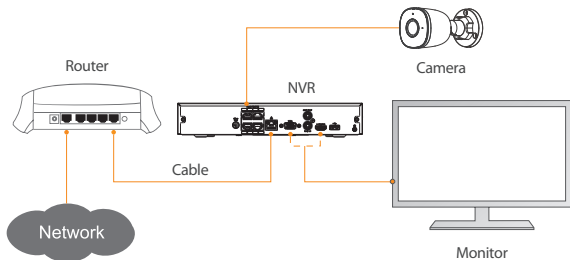

## Scene2:

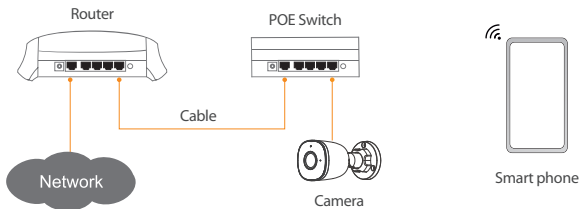

The pattern of the LED indicator is included in the following table.

LED Indicator Status	Device Status
Off	<ul style="list-style-type: none"><li>● Powered off/LED turned off</li></ul>
Red light on	<ul style="list-style-type: none"><li>● Booting</li><li>● Device malfunction</li></ul>
Green light on	<ul style="list-style-type: none"><li>● Operating properly</li></ul>
Red light flashing	<ul style="list-style-type: none"><li>● Network connection failed</li></ul>
Green and red lights flashing alternately	<ul style="list-style-type: none"><li>● Firmware updating</li></ul>

1

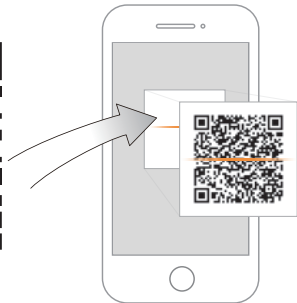
**Imou Life**Download on the  
App StoreGET IT ON  
Google play

Windows

2



### 3 Ceiling Mounting

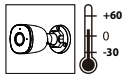
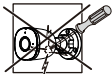
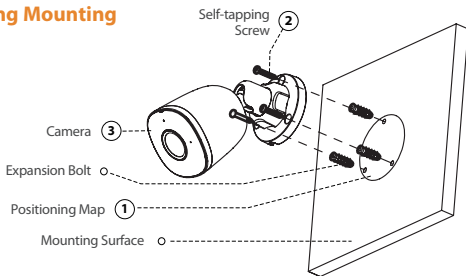

Problem	Solution
The camera cannot work normally or start	<ul style="list-style-type: none"> <li>• Make sure that the network cable is connected well, and the NVR or switch supports POE power supply.</li> </ul>
Where are the recorded videos saved	<ul style="list-style-type: none"> <li>• Scene1 Recorded videos are saved in NVR.</li> <li>• Scene2 When the Imou cloud is enabled, recorded videos are saved in Imou cloud.</li> <li>• Scene3 The infrared light is reflected to the lens, so the effect is not good.Adjust the lens angle to avoid occlusions around the lens.</li> </ul>
The IR effect is not good	<ul style="list-style-type: none"> <li>• The infrared light is reflected to the lens, so the effect is not good.Adjust the lens angle to avoid occlusions around the lens.</li> </ul>

# Kurzanleitung

## F22A

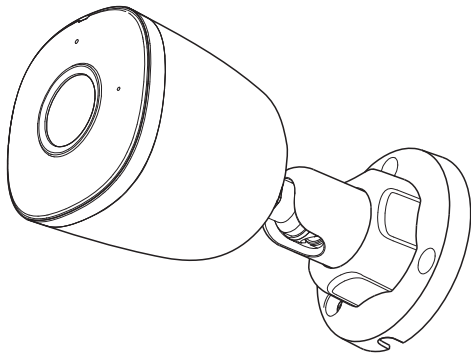



# Willkommen

Vielen Dank, dass Sie sich für IMOUE entschieden haben. Wir sind bestrebt, einfachere Produkte für das intelligente Heim anzubieten. Wenn Sie Probleme bei der Verwendung des Produkts haben, wenden Sie sich bitte an unser Serviceteam.

Unsere Service-Mail lautet: [service.global@imoulife.com](mailto:service.global@imoulife.com)

Häufig gestellte Fragen finden Sie unter [imoulife.com/support/help](https://imoulife.com/support/help)



## Packungsinhalt

DE



Kamera x1



Montageschablone x1

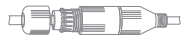

Wasserdichter Anschluss x1



Schrauben x1



Kurzanleitung x1

## Einführung in die Kamera

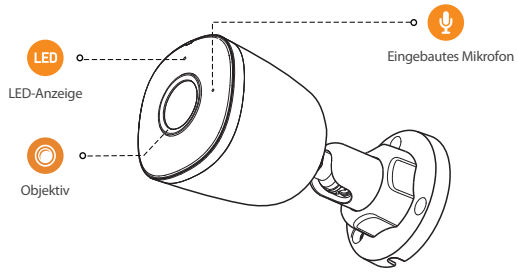

## Szene1:

DE

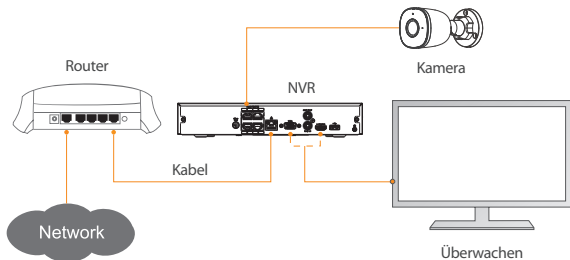

## Szene2:

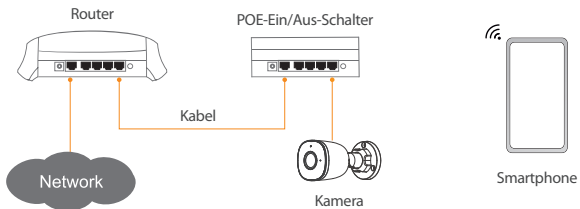

Das Muster der LED-Anzeigen ist in der folgenden Tabelle aufgeführt.

DE

LED-Status/Gerätstatus	Device Status
AUS	● Abgeschaltet/LED Ausgeschaltet
Rote LED leuchtet	● Gerät fährt hoch ● Geräteörung
Grüne LED leuchtet	● Ordnungsgemäßer Betrieb
Rechte LED blinkt	● Netzwerkverbindung fehlgeschlagen
Grüne und rote LED blinken abwechselnd	● Firmware-Update

1

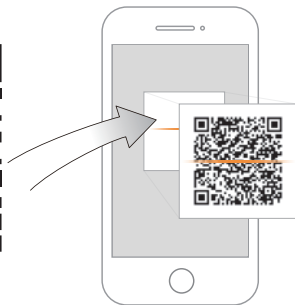

Imou Life

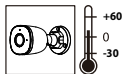
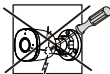
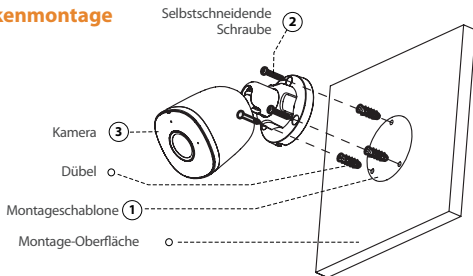

**2****DE****3 Deckenmontage**

## Fehlerbehebung

DE

Problem	Lösungen
Die Kamera funktioniert oder startet nicht ordnungsgemäß	<ul style="list-style-type: none"><li>• Stellen Sie sicher, dass das Netzkabel richtig angeschlossen ist und der NVR oder Switch Stromversorgung per POE unterstützt.</li></ul>
Wo werden die aufgezeichneten Videos gespeichert?	<ul style="list-style-type: none"><li>• Szene1 Aufgezeichnete Videos werden auf dem NVR gespeichert.</li><li>• Szene2 Wenn die Imou-Cloud aktiviert ist, werden aufgezeichnete Videos in der Imou-Cloud gespeichert.</li><li>• Szene3 Das Infrarotlicht wird zum Objektiv reflektiert, sodass die Wirkung nicht gut ist. Stellen Sie den Objektivwinkel ein, um Reflexionen um die Linse herum zu vermeiden.</li></ul>
Die IR-Wirkung ist nicht gut	<ul style="list-style-type: none"><li>• Das Infrarotlicht wird zum Objektiv reflektiert, sodass die Wirkung nicht gut ist. Stellen Sie den Objektivwinkel ein, um Reflexionen um die Linse herum zu vermeiden.</li></ul>

# Guía de inicio rápido

## F22A

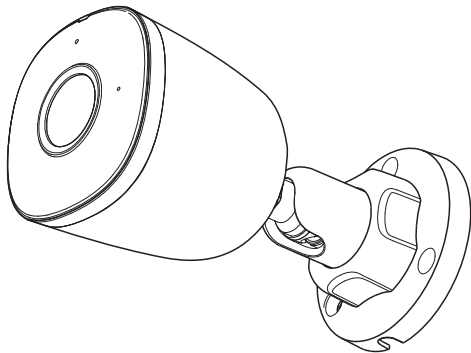

# Bienvenido

ES

Gracias por elegir IMOU

Nuestra misión es proporcionar productos fáciles de usar para un hogar inteligente. Si tiene problemas usando el producto, por favor dirijase a nuestro equipo de atención al cliente antes de devolver su producto.

Nuestro correo electrónico de servicio:  
[service.global@imoulife.com](mailto:service.global@imoulife.com)

Nos comprometemos a contestarle en 24 horas.

Puede encontrar respuesta a las preguntas más frecuentes en  
[imoulife.com/support/help](http://imoulife.com/support/help)





## Contenido del paquete

ES

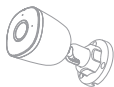

Cámara x1



Plantilla de posicionamiento x1



Conector a prueba de agua x1



Bolsa con tornillosx1



Guía de inicio rápidox1

## Introducción a la cámara

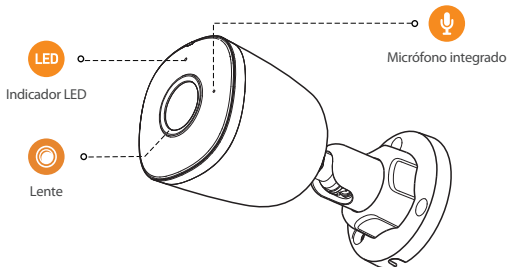

## Escena1:

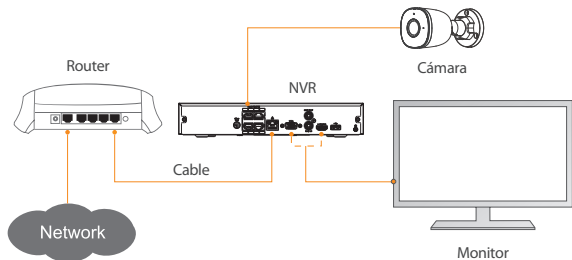

## Escena2:

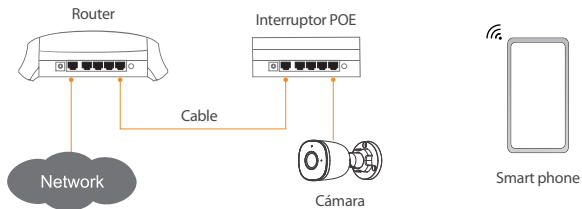

## El patrón de los indicadores LED se incluye en la siguiente tabla.

ES

Estado LED	Estado del aparato
APAGADA	<ul style="list-style-type: none"><li>● Apagada/LED apagada</li></ul>
Luz roja encendida	<ul style="list-style-type: none"><li>● Arranque</li><li>● Avería del dispositivo</li></ul>
Luz verde encendida	<ul style="list-style-type: none"><li>● Funcionando correctamente</li></ul>
Luz derecha parpadeante	<ul style="list-style-type: none"><li>● Fallo de conexión de red</li></ul>
Luz verde y luz roja parpadeando alternativamente	<ul style="list-style-type: none"><li>● Actualización de firmware</li></ul>

1

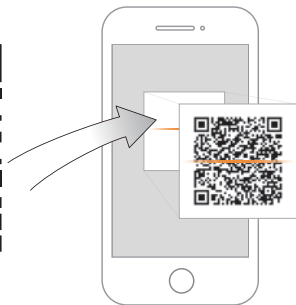

Imou Life



2



### 3 Montaje en el techo

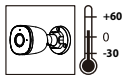
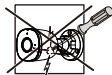
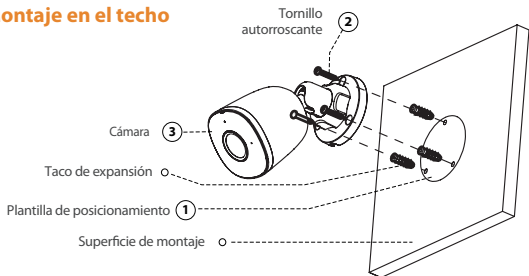

## Solución de problemas

Problema	Solución
La cámara no funciona con normalidad o no se inicia	<ul style="list-style-type: none"><li>• Asegúrese de que el cable de red esté bien conectado y que el NVR o el interruptor acepten la alimentación POE.</li></ul>
¿Dónde se guardan los videos grabados?	<ul style="list-style-type: none"><li>• Escena1 Los videos grabados se guardan en el NVR.</li><li>• Escena2 Cuando la nube Imou se activa, los videos grabados se guardan en ella.</li><li>• Escena3 L luz infrarroja se refleja en la lente, por lo que el efecto no es bueno. Ajuste el ángulo de la lente para evitar oclusiones alrededor de la lente.</li></ul>
El efecto IR no es bueno	<ul style="list-style-type: none"><li>• L luz infrarroja se refleja en la lente, por lo que el efecto no es bueno. Ajuste el ángulo de la lente para evitar oclusiones alrededor de la lente.</li></ul>

# Guide de démarrage rapide

F22A

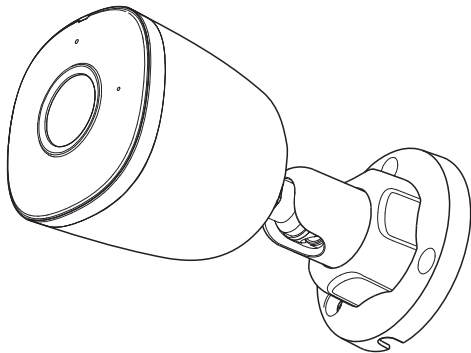

# Bienvenue

FR

Merci d'avoir choisi IMOU.

Nous nous consacrons à fournir des produits pour la maison intelligente plus faciles à utiliser. Si vous rencontrez des difficultés lors de l'utilisation du produit, veuillez contacter notre équipe technique avant de renvoyer votre produit.

Notre courriel de service : [service.global@imoulife.com](mailto:service.global@imoulife.com)

Nous nous engageons à vous répondre dans les 24 heures.

Les questions les plus fréquemment posées peuvent être consultées sur le site [imoulife.com/support/help](https://imoulife.com/support/help)



## Contenu de l'emballage

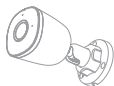

Caméra x1



Patron d'installation x1



Connecteur étanche x1

FR



Paquet de vis x1



Guide de démarrage rapide x1

## Introduction à la caméra

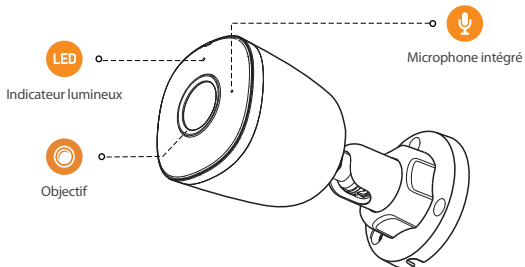



## Scène1:

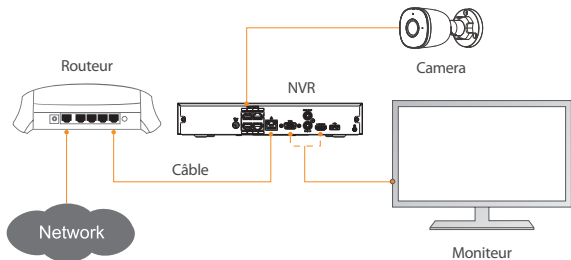

## Scène2:

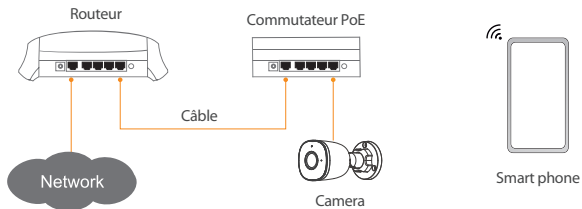

## Le schéma des voyants est inclus dans le tableau suivant.

Statut du voyant	État de l'appareil
ARRÊT	● Éteint/Voyant éteint
Allumé en rouge	● Amorçage ● Fonctionnement défectueux de l'appareil
Allumé en vert	● Fonctionnement normal
Clignotement du voyant droit	● Échec de connexion au réseau
Voyant vert et voyant rouge clignotant en alternance	● Mise à jour du micrologiciel

FR

1

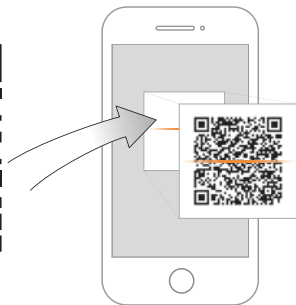

Imou Life



2



### 3 Montage au plafond

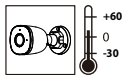
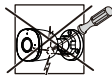
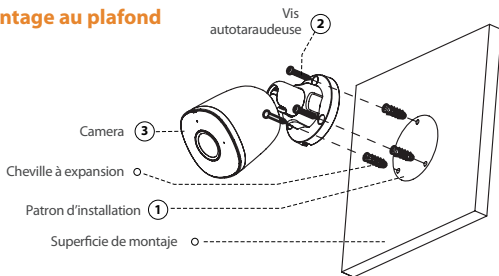

## Dépannage

Problème	Solution
La caméra ne peut ni démarrer ni fonctionner normalement	<ul style="list-style-type: none"><li>• Vérifiez que le câble réseau est bien connecté et que le NVR ou le commutateur prend en charge l'alimentation PoE.</li></ul>
Où sont stockées les vidéos enregistrées	<ul style="list-style-type: none"><li>• Scène1 Les vidéos enregistrées sont stockées dans le NVR.</li><li>• Scène2 Une fois le cloud Imou activé, les vidéos enregistrées y sont stockées.</li><li>• Scène3 Le résultat n'est pas de bonne qualité car la lumière IR réfléchit sur l'objectif. Ajustez l'angle de l'objectif pour éviter les occultations autour de celui-ci.</li></ul>
L'effet IR n'est pas de bonne qualité	<ul style="list-style-type: none"><li>• Le résultat n'est pas de bonne qualité car la lumière IR réfléchit sur l'objectif. Ajustez l'angle de l'objectif pour éviter les occultations autour de celui-ci.</li></ul>

# Guida Rapida

F22A

IT

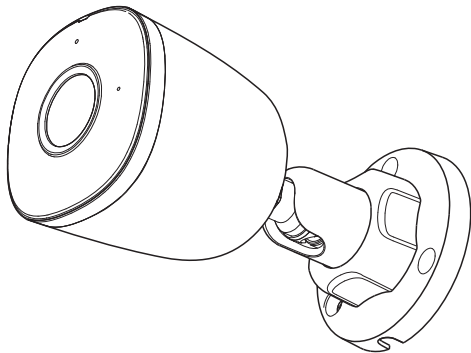

# Benvenuti

IT

Grazie per aver scelto IMOU.

Il nostro obiettivo è quello di fornire prodotti per la domotica più facili da utilizzare. In caso di problemi durante l'utilizzo del prodotto, si prega di contattare il nostro team di assistenza prima di restituire il prodotto.

La nostra e-mail per il servizio di assistenza:  
[service.global@imoulife.com](mailto:service.global@imoulife.com)

Promettiamo di rispondere entro 24 ore.

Le risposte alle domande più frequenti sono disponibili all'indirizzo [imoulife.com/support/help](https://imoulife.com/support/help)

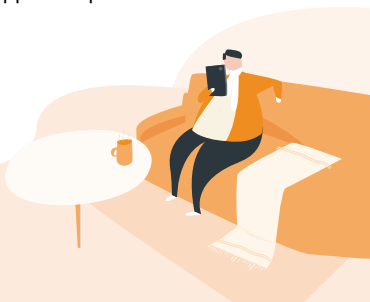

## Contenuto della confezione

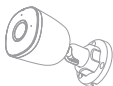

Telecamera x1



Dima di posizionamento x1

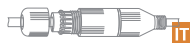

Connettore impermeabile x1



Kit di viti x1



Guida introduttiva x1

## Introduzione alla telecamera

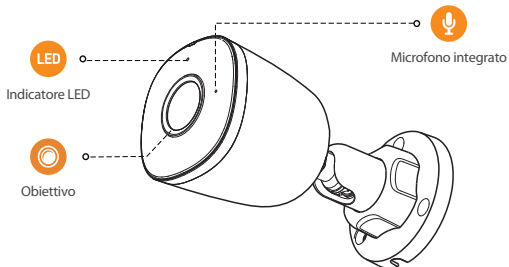

## Scene1:

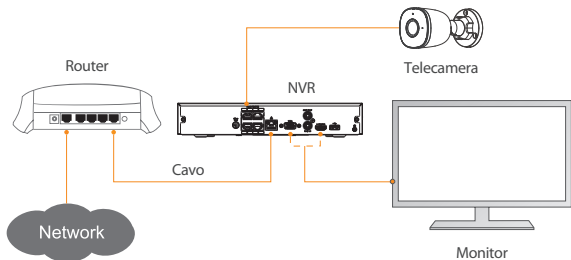

## Scene2:

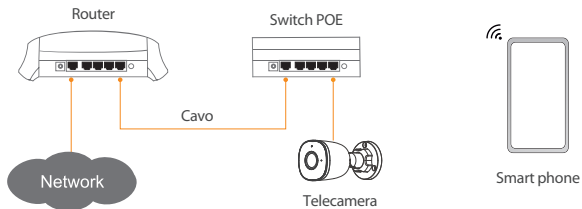



**Gli indicatori LED sono descritti nella tabella seguente.**

Stato LED	Stato dispositivo
SPENTO	<ul style="list-style-type: none"><li>● Spento/LED spento</li></ul>
Luce rossa accesa	<ul style="list-style-type: none"><li>● Avvio</li><li>● Malfunzionamento del dispositivo</li></ul>
Luce verde accesa	<ul style="list-style-type: none"><li>● Funzionamento normale</li></ul>
Luce rossa lampeggiante	<ul style="list-style-type: none"><li>● Connessione di rete non riuscita</li></ul>
La luce verde e quella rossa lampeggiano in alternanza	<ul style="list-style-type: none"><li>● Aggiornamento del firmware</li></ul>

IT

1

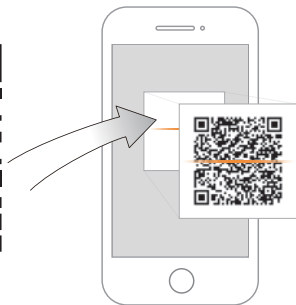

Imou Life



Download on the  
App Store



GET IT ON  
Google play



Windows

2

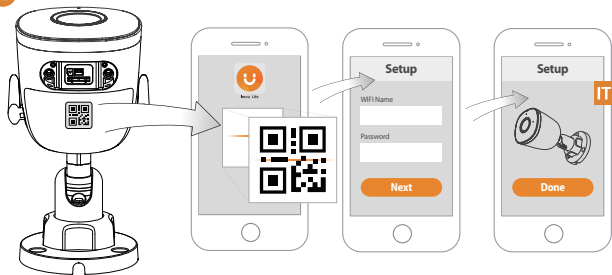

### 3 Montaggio a soffitto

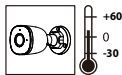
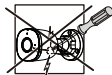
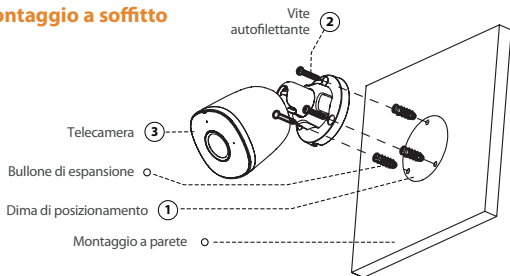

## Risoluzione dei problemi

Problema	Soluzione
La telecamera non funziona o non si avvia normalmente	<ul style="list-style-type: none"><li>• Accertarsi che il cavo di rete sia collegato in modo corretto e che l'NVR o lo switch supportino l'alimentazione POE.</li></ul>
Dove vengono salvati i video registrati	<ul style="list-style-type: none"><li>• Scene1 I video registrati vengono salvati sull'NVR.</li><li>• Scene2 I video vengono salvati sul cloud Imou se questo è attivo.</li><li>• Scene3 La luce a infrarossi si riflette sull'obiettivo e il risultato non è buono. Per evitare occlusioni intorno all'obiettivo, regolarne l'angolo.</li></ul>
L'effetto IR non è buono	<ul style="list-style-type: none"><li>• La luce a infrarossi si riflette sull'obiettivo e il risultato non è buono. Per evitare occlusioni intorno all'obiettivo, regolarne l'angolo.</li></ul>

# Snelstartgids

F22A

NL

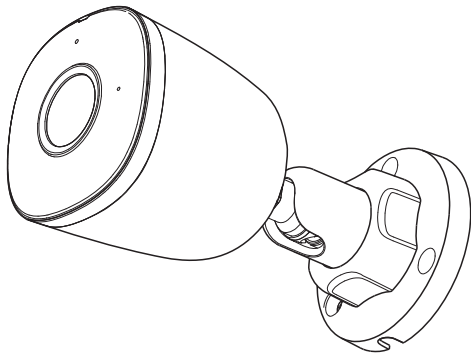

# Welkom

Bedankt dat u voor Imou heeft gekozen.

NL

Onze toewijding is om u eenvoudige Smart Home producten te bieden. Als u problemen ervaart met het gebruik van uw product, neem dan eerst contact op met onze service team: [service.global@imoulife.com](mailto:service.global@imoulife.com)



## Inhoud verpakking

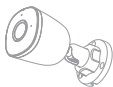

Camera x1



Kaart installatiepositie x1



Waterdichte connector x1

NL



Schroevenset x1



Snel startgids x1

## Introductie camera

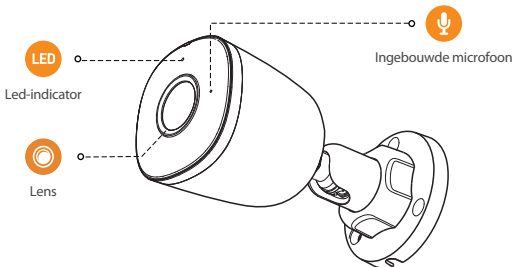

## Scène1:

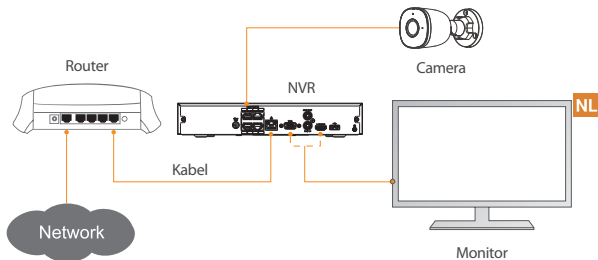

## Scène2:

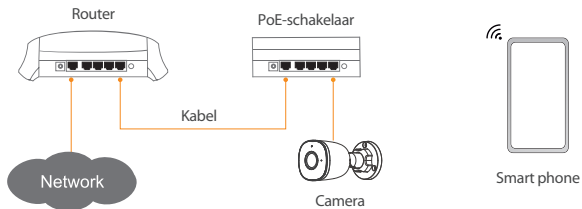

Het patroon van led-indicatoren wordt weergegeven in de volgende tabel.

Ledstatus	apparaatstatus
UIT	<ul style="list-style-type: none"><li>• Uitgeschakeld/led uit</li></ul>
Rood lampje aan	<ul style="list-style-type: none"><li>• bezig met opstarten</li><li>• Storing van het apparaat</li></ul>
Groen lampje aan	<ul style="list-style-type: none"><li>• Werkt zoals dat moet</li></ul>
Rood lampje knippert	<ul style="list-style-type: none"><li>• Netwerkverbinding mislukt</li></ul>
Groen lampje en rood lampje knipperen afwisselend	<ul style="list-style-type: none"><li>• Bijwerken firmware</li></ul>

NL

1

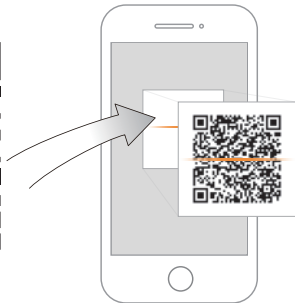

Imou Life



Download on the  
App Store



GET IT ON  
Google play



Windows



2



### 3 Plafondbevestiging

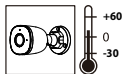
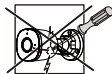
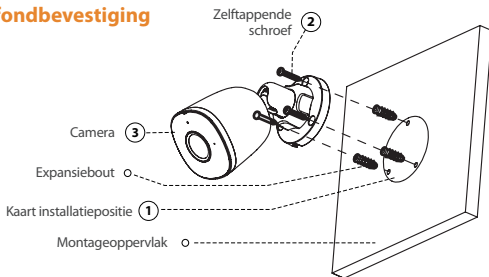

## Probleemoplossing

Probleem	Oplossing
De camera kan niet normaal functioneren of opstarten	• Zorg dat de netwerkkabel correct is aangesloten en dat de NVR of switch de POE-voeding ondersteunt.
Waar worden de opgenomen video's opgeslagen	<ul style="list-style-type: none"><li>• Scène1 Opgenomen video's worden opgeslagen in NVR.</li><li>• Scène2 Als de Imou-cloud is ingeschakeld, worden opgenomen video's opgeslagen in de Imou-cloud.</li><li>• Scène3 Het infraroodlicht wordt weerkaatst op de lens, waardoor het effect niet goed is. Pas de lenshoek aan om occlusies rond de lens te voorkomen.</li></ul>
Het infraroodeffect is niet goed	• Het infraroodlicht wordt weerkaatst op de lens, waardoor het effect niet goed is. Pas de lenshoek aan om occlusies rond de lens te voorkomen.

# Guia rápido

## F22A

PT

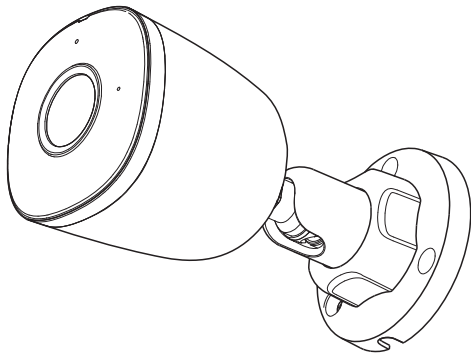

# Bem-vindo

Obrigado por escolher a IMOU.

Estamos empenhados em fornecer produtos inteligentes e simplificados para o lar. Se tiver problemas ao utilizar o produto, contacte a nossa equipa de assistência antes de devolver o produto.

PT

O nosso e-mail de assistência: [service.global@imoulife.com](mailto:service.global@imoulife.com)  
Prometemos responder no prazo de 24 horas.

Pode encontrar as Perguntas frequentes em [imoulife.com/support/help](https://imoulife.com/support/help)



## Conteúdo da embalagem

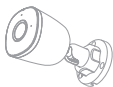

Câmarax1



Mapa de posicionamento x1



Conector impermeável x1

PT



Conjunto de parafusosx1



Snel startgidsx1

## Apresentação da câmara

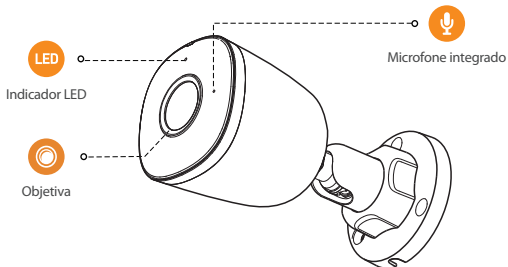

### Cena1:

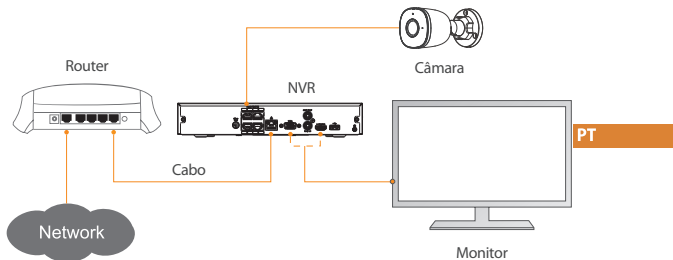

### Cena2:

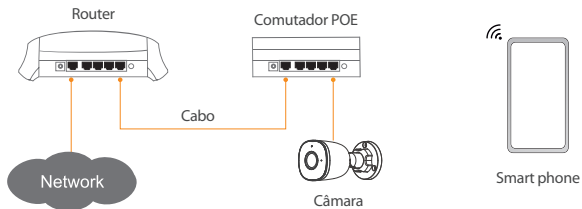

## O padrão dos indicadores LED está incluído na tabela seguinte.

Estado do LED	Estado do dispositivo
DESLIGADO	<ul style="list-style-type: none"><li>• Desligado/LED desligado</li></ul>
Luz vermelha acesa	<ul style="list-style-type: none"><li>• Arranque</li><li>• Avaria do dispositivo</li></ul>
Luz verde acesa	<ul style="list-style-type: none"><li>• A funcionar corretamente</li></ul>
Luz vermelha intermitente	<ul style="list-style-type: none"><li>• Ligação à rede falhou</li></ul>
Luz verde e luz vermelha intermitentes alternadamente	<ul style="list-style-type: none"><li>• Atualização do firmware</li></ul>

PT

1

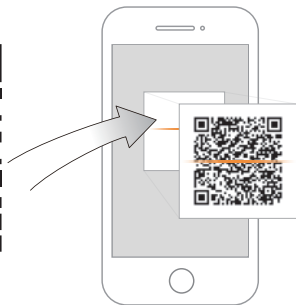

Imou Life



2



### 3 Montagem no teto

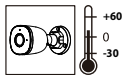
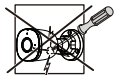
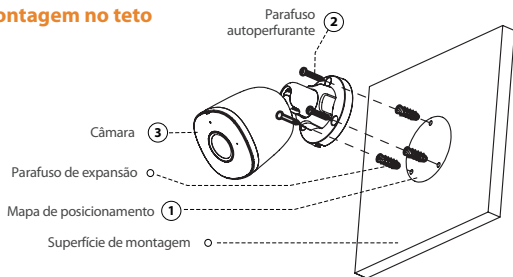



## Solução de problema

Problema	Solução
A câmara não funciona normalmente ou não inicia	<ul style="list-style-type: none"><li>• Certifique-se de que o cabo de rede está bem ligado, e se o NVR ou computador suporta a alimentação tipo POE.</li></ul>
Onde se encontram guardados os vídeos gravados	<ul style="list-style-type: none"><li>• Cena1 Os vídeos gravados estão guardados no NVR.</li><li>• Cena2 Quando a nuvem Imou está ativada, os vídeos gravados são guardados na nuvem Imou.</li><li>• Cena3 A luz infravermelha é refletida na lente, por isso o efeito não é satisfatório. Ajuste o ângulo da lente para evitar oclusões em volta da lente.</li></ul>
O efeito de IV não é satisfatório	<ul style="list-style-type: none"><li>• A luz infravermelha é refletida na lente, por isso o efeito não é satisfatório. Ajuste o ângulo da lente para evitar oclusões em volta da lente.</li></ul>

PT

# imou

Enjoy Smart Life



CE FC CCC UL  ISO 9001:2000

 @imouglobal

 service.global@imoulife.com

 www.imoulife.com