

MERCUSYS[®]

User Guide

AX1500 Wi-Fi 6 Router

MR60X

CE Mark Warning



This is a class B product. In a domestic environment, this product may cause radio interference, in which case the user may be required to take adequate measures.

OPERATING FREQUENCY (the maximum transmitted power)

2400 MHz -2483.5MHz (20 dBm)

5150 MHz -5250 MHz (23 dBm)

Frequency band 5150 - 5250 MHz:

Indoor use: Inside buildings only. Installations and use inside road vehicles and train carriages are not permitted. Limited outdoor use: If used outdoors, equipment shall not be attached to a fixed installation or to the external body of road vehicles, a fixed infrastructure or a fixed outdoor antenna. Use by unmanned aircraft systems (UAS) is limited to within the 5170 - 5250 MHz band.

EU Declaration of Conformity

Mercusys hereby declares that the device is in compliance with the essential requirements and other relevant provisions of directives 2014/53/EU, 2009/125/EC, 2011/65/EU and (EU)2015/863.

The original EU declaration of conformity may be found at <http://www.mercusys.com/en/ce>.

RF Exposure Information

This device meets the EU requirements (2014/53/EU Article 3.1a) on the limitation of exposure of the general public to electromagnetic fields by way of health protection.

The device complies with RF specifications when the device used at 20 cm from your body.

National restrictions

Attention: This device may only be used indoors in all EU member states, EFTA countries and Northern Ireland.

	AT	BE	BG	CH	CY	CZ	DE	DK
	EE	EL	ES	FI	FR	HR	HU	IE
	IS	IT	LI	LT	LU	LV	MT	NL
	NO	PL	PT	RO	SE	SI	SK	UK(NI)

UK Declaration of Conformity



Mercusys hereby declares that the device is in compliance with the essential requirements

and other relevant provisions of the Radio Equipment Regulations 2017.

The original UK Declaration of Conformity may be found at <https://www.mercusys.com/support/ukca/>

National restrictions

Attention: This device may only be used indoors in Great Britain.

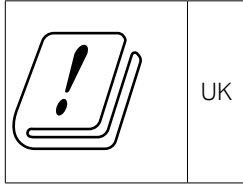

Продукт сертифіковано згідно з правилами системи УкрСЕПРО на відповідність вимогам нормативних документів та вимогам, що передбачені чинними законодавчими актами України.

EAC

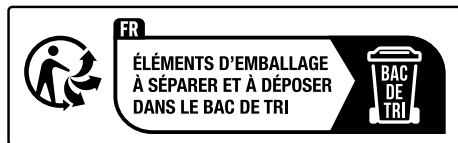

Korea Warning Statements

당해 무선설비는 운용중 전파혼신 가능성이 있음.

NCC Notice & BSMI Notice:

注意!

取得審驗證明之低功率射頻器材，非經核准，公司、商號或使用者均不得擅自變更頻率、加大功率或變更原設計之特性及功能。

低功率射頻器材之使用不得影響飛航安全及干擾合法通信；經發現有干擾現象時，應立即停用，並改善至無干擾時方得繼續使用。

前述合法通信，指依電信管理法規定作業之無線電通信。

低功率射頻器材須忍受合法通信或工業、科學及醫療用電波輻射性電機設備之干擾。

應避免影響附近雷達系統之操作。

高增益指向性天線只得應用於固定式點對點系統。

安全諮詢及注意事項

- 請使用原裝電源供應器或只能按照本產品注明的電源類型使用本產品。
- 清潔本產品之前請先拔掉電源線。請勿使用液體、噴霧清潔劑或濕布進行清潔。
- 注意防潮，請勿將水或其他液體潑灑到本產品上。
- 插槽與開口供通風使用，以確保本產品的操作可靠並防止過熱，請勿堵塞或覆蓋開口。
- 請勿將本產品置放於靠近熱源的地方。除非有正常的通風，否則不可放在密閉位置中。
- 不要私自拆開機殼或自行維修，如產品有故障請與原廠或代理商聯繫。

限用物質含有情況標示聲明書

設備名稱：AX1500 Wi-Fi 6 Router Equipment name			型號（型式）：MR60X Type designation (Type)			
單元 Unit	限用物質及其化學符號 Restricted substances and its chemical symbols					
	鉛 Lead (Pb)	汞 Mercury (Hg)	鎘 Cadmium (Cd)	六價鉻 Hexavalent chromium (Cr ⁺⁶)	多溴聯苯 Polybrominated biphenyls (PBB)	多溴二苯醚 Polybrominated diphenyl ethers (PBDE)
PCB	○	○	○	○	○	○
外殼	○	○	○	○	○	○
電源供應器	—	○	○	○	○	○
天線	○	○	○	○	○	○
備考 1. "超出 0.1 wt %" 及 "超出 0.01 wt %" 係指限用物質之百分比含量超出百分比含量基準值。						
備考 2. "○" 係指該項限用物質之百分比含量未超出百分比含量基準值。						
備考 3. "—" 係指該項限用物質為排除項目。						

Safety Information









- Keep the device away from water, fire, humidity or hot environments.
- Do not attempt to disassemble, repair, or modify the device. If you need service, please contact us.
- Do not use damaged charger or USB cable to charge the device.
- Do not use any other chargers than those recommended.
- Do not use the device where wireless devices are not allowed.

- Adapter shall be installed near the equipment and shall be easily accessible.
- Use only power supplies which are provided by manufacturer and in the original packing of this product. If you have any questions, please don't hesitate to contact us.
- Operating Temperature: 0°C~40°C (32°F~104°F)
- This product uses radios and other components that emit electromagnetic fields. Electromagnetic fields and magnets may interfere with pacemakers and other implanted medical devices. Always keep the product and its power adapter more than 15 cm (6 inches) away from any pacemakers or other implanted medical devices. If you suspect your product is interfering with your pacemaker or any other implanted medical device, turn off your product and consult your physician for information specific to your medical device.

Please read and follow the above safety information when operating the device. We cannot guarantee that no accidents or damage will occur due to improper use of the device. Please use this product with care and operate at your own risk.

Explanation of the symbols on the product label

The product label is at the bottom of the router.

Symbol	Explanation
	Class II equipment
	Alternating current
	Direct current
	For indoor use only
	Polarity of d.c. power connector
	Energy efficiency Marking
	Caution
	Operator's manual
	<p>RECYCLING</p> <p>This product bears the selective sorting symbol for Waste electrical and electronic equipment (WEEE). This means that this product must be handled pursuant to European directive 2012/19/EU in order to be recycled or dismantled to minimize its impact on the environment.</p> <p>User has the choice to give his product to a competent recycling organization or to the retailer when he buys a new electrical or electronic equipment.</p>

Contents

Conventions	01
Chapter 1. Introduction	02
1.1. Product Overview	02
1.2. Product Appearance	02
1.2.1. Front Panel	02
1.2.2. Rear Panel	03
Chapter 2. Connect to the Internet	04
2.1. Position Your Router	04
2.2. Connect the Hardware	05
2.3. Set Up the Router	05
2.3.1. Method 1: Via Web Browser	05
2.3.2. Method 2: Via MERCUSYS App	07
Chapter 3. Log In to the Router	09
Chapter 4. Configure the Router in Wireless Router Mode	10
4.1. Operation Mode	10
4.2. Quick Setup	11
4.3. Network	11
4.3.1. Status	11
4.3.2. Internet	13
4.3.3. MAC Clone	18
4.3.4. NAT	19
4.3.5. Internet Port Negotiation Speed Setting	19
4.3.6. LAN	20
4.3.7. IPTV/VLAN	20
4.3.8. Multicast	21
4.3.9. DHCP Server	21
4.3.10. Dynamic DNS	23
4.3.11. Static Routing	24
4.4. Mercusys ID	26
4.5. Wireless	27
4.5.1. Wireless Settings	27
4.5.2. Guest Network	29
4.5.3. Wireless Schedule	30

4.5.4.	WPS	31
4.5.5.	Additional Settings.....	33
4.6.	NAT Forwarding.....	34
4.6.1.	Port Forwarding.....	35
4.6.2.	Port Triggering.....	36
4.6.3.	UPnP	37
4.6.4.	DMZ	39
4.7.	Parental Controls	40
4.8.	QoS	42
4.9.	Security	43
4.9.1.	Firewall	43
4.9.2.	Access Control	44
4.9.3.	IP & MAC Binding	46
4.9.4.	ALG.....	47
4.10.	IPv6	48
4.11.	System.....	51
4.11.1.	Firmware Update.....	51
4.11.2.	Backup & Restore	53
4.11.3.	Change Password.....	54
4.11.4.	Password Recovery	54
4.11.5.	Local Management	55
4.11.6.	Remote Management	57
4.11.7.	System Log.....	59
4.11.8.	Diagnostics.....	60
4.11.9.	Time.....	62
4.11.10.	Language	63
4.11.11.	Reboot	63
4.11.12.	LED Control	64
4.11.13.	CWMP Settings.....	65
Chapter 5. Configure the Router in Access Point Mode		68
5.1.	Operation Mode	68
5.2.	Quick Setup	69
5.3.	Firmware Update	69
5.4.	Backup & Restore.....	70
5.5.	Administration.....	72
5.5.1.	Change Password.....	72
5.5.2.	Password Recovery	72
5.5.3.	Local Management	73

5. 6.	System Log	74
5. 7.	Diagnostics.....	76
5. 8.	Time.....	77
5. 9.	Language.....	79
5. 10.	Reboot	79
5. 11.	LED Control	80
FAQ	81

Conventions

The router, or MR60X mentioned in this User Guide stands for AX1500 Wi-Fi 6 Router without any explanations.

Parameters provided in the pictures are just references for setting up the product, which may differ from the actual situation.

You can set the parameters according to your demand.

More Info

Specifications and the latest software can be found at the product page at the official website <http://www.mercusys.com>.

The Quick Installation Guide can be found where you find this guide or inside the package of the router.

*Maximum wireless signal rates are the physical rates derived from IEEE Standard 802.11 specifications. Actual wireless data throughput, wireless coverage, and number of connected devices are not guaranteed and will vary as a result of network conditions, client limitations, and environmental factors, including building materials, obstacles, volume and density of traffic, and client location.

*Use of 802.11ax (Wi-Fi 6), and features including OFDMA, MU-MIMO, 1024-QAM, BSS Color, and Target Wake Time (TWT) requires clients to also support the corresponding features. Actual power reduction by Target Wake Time may vary as a result of network conditions, client limitations, and environmental factors.

*The 802.11ax white paper defines standardized modifications to both the IEEE 802.11 physical layers (PHY) and the IEEE 802.11 Medium Access Control (MAC) layer as enabling at least one mode of operation capable of supporting improvement of at least four times the average throughput per station (measured at the MAC data service access point) in a dense deployment scenario.

*Use of WPA3 requires clients to also support WPA3.

Chapter 1. Introduction

1.1. Product Overview

Featuring 1024-QAM, the router offers dramatically fast wireless connections up to 1.5 Gbps. Experience smooth large-file downloads and uploads, stutter-free VR, and stunning 4K streaming without lag. With MU-MIMO and OFDMA, the router transmits data to and from multiple devices at the same time for 4× more capacity, greatly reducing lag and increasing transmission efficiency under the same conditions.

1.2. Product Appearance

1.2.1. Front Panel



The router's System LED is located on the front panel.

Status	Indication
Off	Power is off or the system is running abnormally.
Green	Solid on: The router is functioning normally and the wireless networks are enabled. Flashing quickly: The WPS connection is in progress Flashing slowly: The router is starting up or upgrading.

Status	Indication
Orange	Solid on: The wireless networks are disabled.

1.2.2. Rear Panel



The following items are located on the rear panel (View from left to right).

Item	Description
POWER Socket	The power socket is where you will connect the power adapter. Please use the power adapter provided with this router.
WAN Port	Use the port as the WAN port to connect the DSL/cable Modem or Ethernet outlet.
LAN Ports	These ports connect the router to the local devices.
RESET/WPS Button	Press and hold this button for more than 5 seconds to reset the router. Press for 1 second to use the WPS function.
Wireless Antennas	To receive and transmit the wireless data.

Item	Indication
WAN Port LED	Off: The WAN port is not connected. On: The WAN port is connected.
LAN Port LED	Off: The LAN port is not connected. On: The LAN port is connected.

Chapter 2. Connect to the Internet

2.1. Position Your Router

- The product should not be located in a place where it will be exposed to moisture or excessive heat.
- Place the router in a location where it can be connected to multiple devices as well as to a power source.
- Make sure the cables and power cord are safely placed out of the way so they do not create a tripping hazard.
- The router can be placed on a shelf or desktop.
- Keep the router away from devices with strong electromagnetic reference, such as Bluetooth devices, cordless phones and microwaves.

Generally, the router is placed on a horizontal surface, such as on a shelf or desktop. The device also can be mounted on the wall as shown in the following figure.

*Image may differ from the actual product.

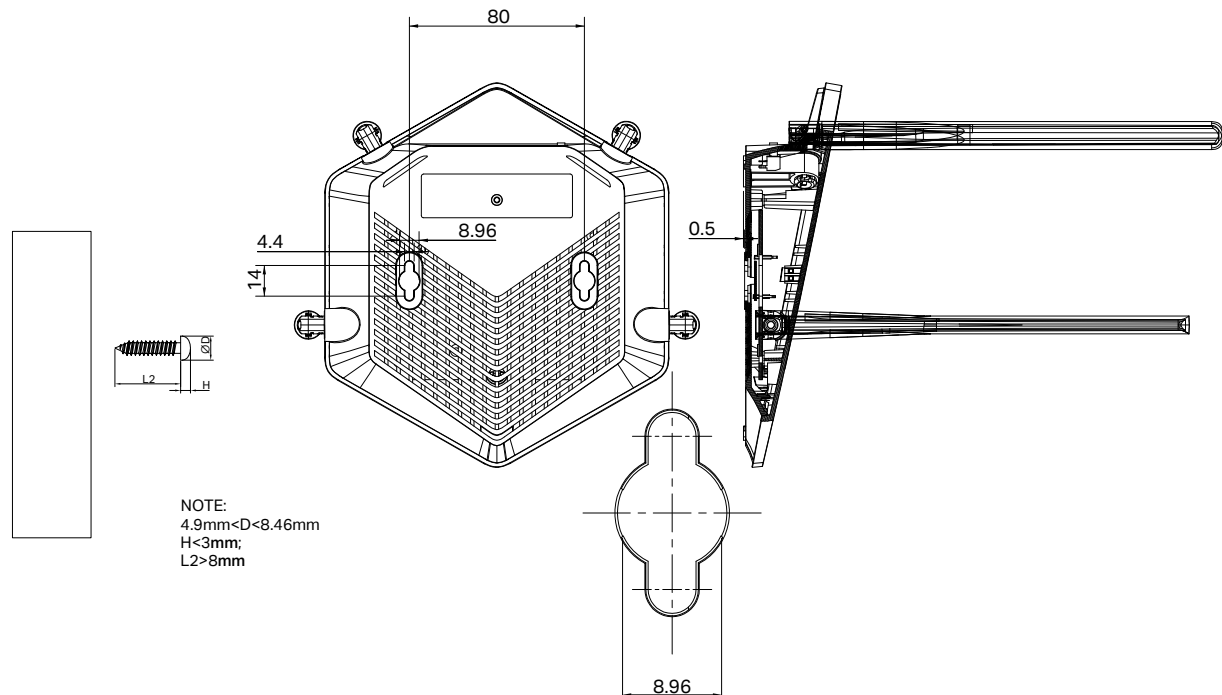

Note:

The diameter of the screw head is $4.9\text{mm} < D < 8.46\text{mm}$, and the distance of two screws is 80mm. The screw that project from the wall need around 3mm based, and the length of the screw need to be at least 8mm to withstand the weight of the product.

2.2. Connect the Hardware

If your Internet connection is through an Ethernet cable from the wall instead of through a DSL/Cable/Satellite modem, connect the Ethernet cable directly to the router's Internet port, then follow sub step 4) to complete the hardware connection.

*Image may differ from actual product.

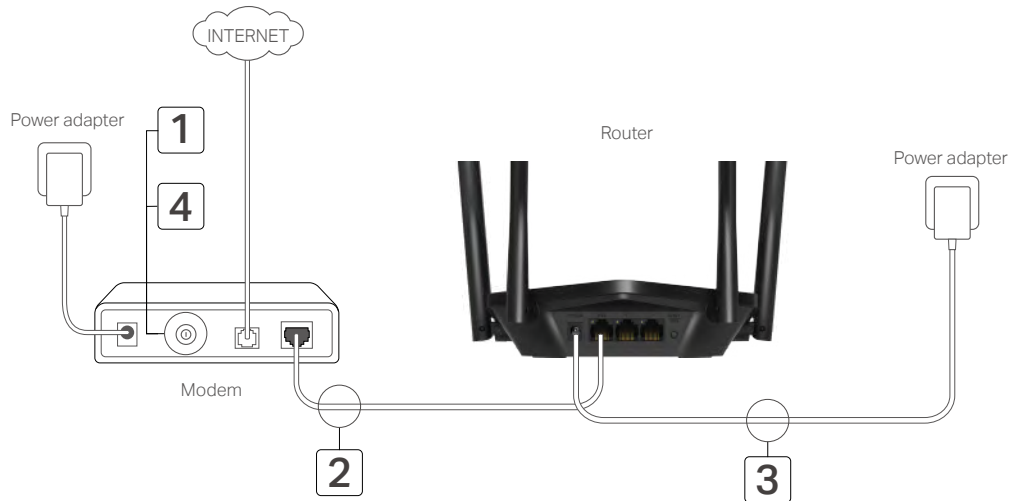

- 1) Turn off the modem, and remove the backup battery if it has one.
- 2) Connect the modem to the router's WAN port with an Ethernet cable.
- 3) Turn on the modem, and then wait about 2 minutes for it to restart.
- 4) Turn on the router.

2.3. Set Up the Router

2.3.1. Method 1: Via Web Browser

Follow the steps below to log in to your router. Before you start, please set your computer to Obtain an IP address automatically.

1. Connect your computer to the router.

- **Method 1: Wired**

Turn off the Wi-Fi on your computer and connect your computer to the router's LAN port using an Ethernet cable.

- **Method 2: Wirelessly**

- 1) Find the SSID (Network Name) and wireless password printed on the label at the bottom of the router.

- 2) Click the network icon of your computer or go to Wi-Fi Settings of your smart device, then select the SSID and enter the wireless password to join the network.
2. Enter **<http://mwlogin.net>** in the address bar of a web browser. Create a password to log in.

Note:

If the login window does not appear, please refer to the [FAQ](#) section.

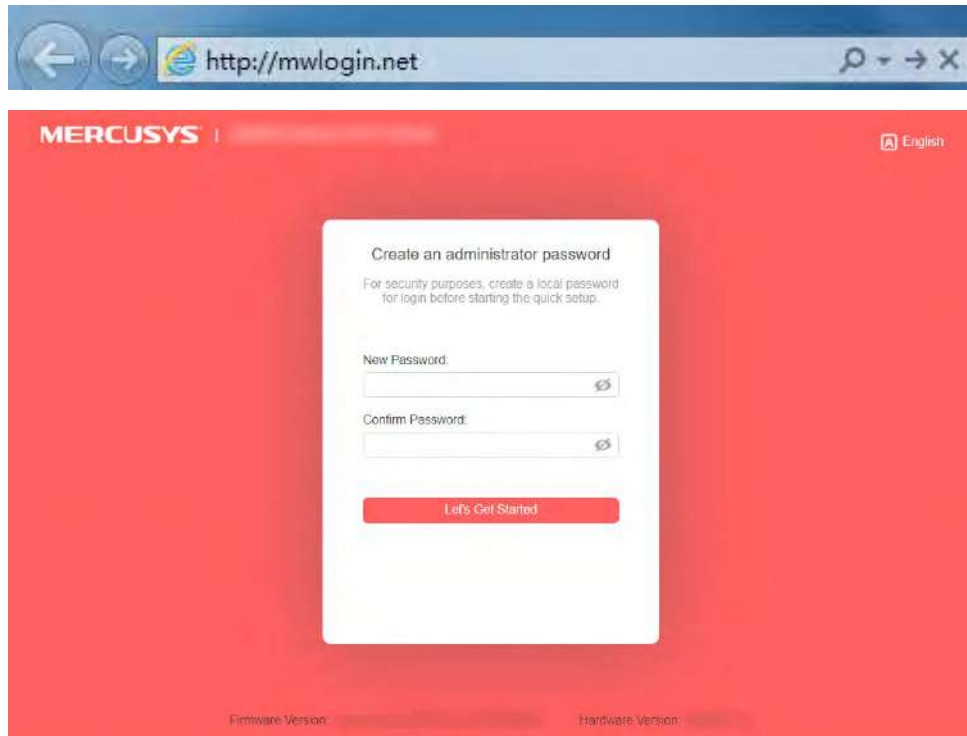

3. Follow the **Quick Setup** to complete the setup.

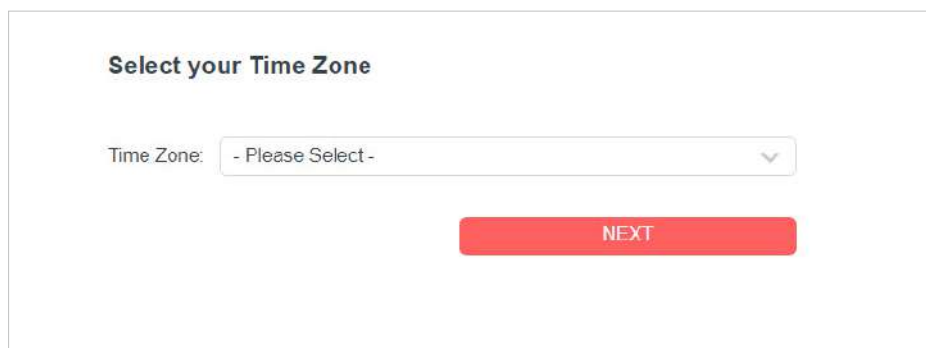
A screenshot of a web form titled 'Select your Time Zone'. It features a dropdown menu labeled 'Time Zone:' with the text '- Please Select -' and a downward arrow. Below the dropdown is a red button labeled 'NEXT'.

4. To enjoy a more complete service from Mercusys (remote management, Mercusys DDNS, and more.), log in with your Mercusys ID to bind the cloud router.

Note: If you don't have an account, create one first.

Get Mercusys Cloud Service

Log In to bind the router to your Mercusys ID. You can manage your network remotely via the Mercusys app, get notified of the latest firmware updates and more.

Mercusys ID (Email):

Password:

[Log In](#)

[Sign Up](#) [Forgot Password?](#)

[SKIP](#)

5. **Enjoy!** For wireless devices, you may have to reconnect to the wireless network if you have customized the SSID (wireless name) and password during the configuration.

2.3.2. Method 2: Via MERCUSYS App

1. Scan the QR code to download the MERCUSYS app from the Apple App Store or Google Play.



2. Launch the app and log in with your Mercusys ID.

Note: If you don't have an account, create one first.

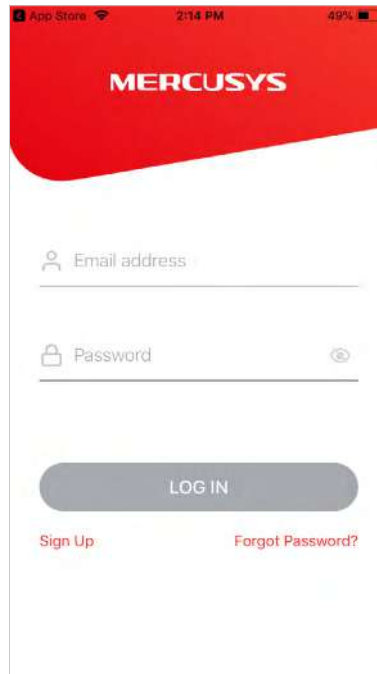

3. Tap **LET'S BEGIN** and select **Router**. Follow app instructions to complete the setup.

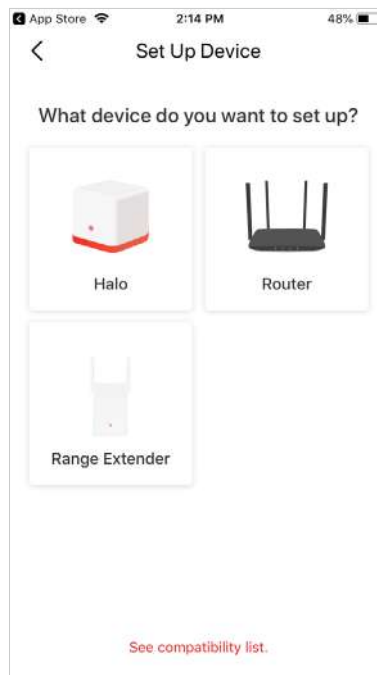

4. **Enjoy!** Connect to the network and enjoy the internet.

Chapter 3. Log In to the Router

This chapter introduces how to log in to the web management page of the router.

With the web-based utility, it is easy to configure and manage the router. The web-based utility can be used on any Windows, Macintosh or UNIX OS with a Web browser, such as Microsoft the Internet Explorer, Mozilla Firefox or Apple Safari.

Follow the steps below to log in to your router.

1. Set up the TCP/IP Protocol in Obtain an IP address automatically mode on your computer.
2. Visit <http://mwlogin.net>, and log in with your Mercusys ID or the password you created.

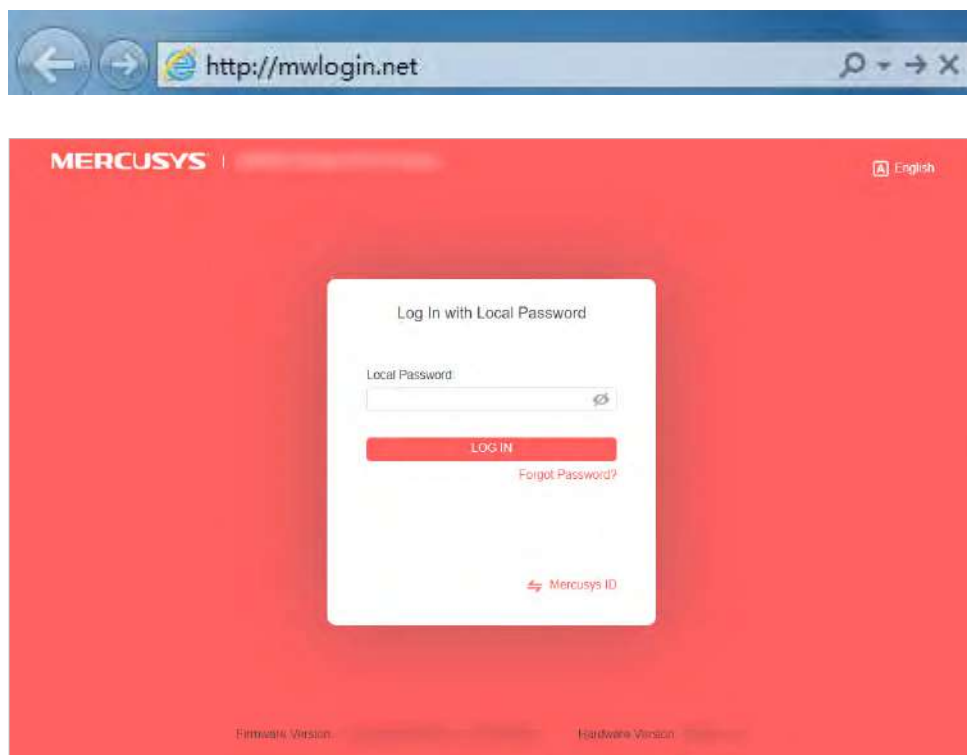

Note:

If the login window does not appear, please refer to the [FAQ](#) section.

Chapter 4. Configure the Router in Wireless Router Mode

This chapter presents how to configure the various features of the router working as a wireless router.

It contains the following sections:

- **Operation Mode**
- **Quick Setup**
- **Network**
- **Mercusys ID**
- **Wireless**
- **NAT Forwarding**
- **Parental Controls**
- **QoS**
- **Security**
- **IPv6**
- **System**

4. 1. Operation Mode

1. Visit **<http://mwlogin.net>**, and log in with your Mercusys ID or the password you set for the router.
2. Go to **Advanced > System > Operation Mode**.
3. Select the working mode as needed and click **SAVE**.

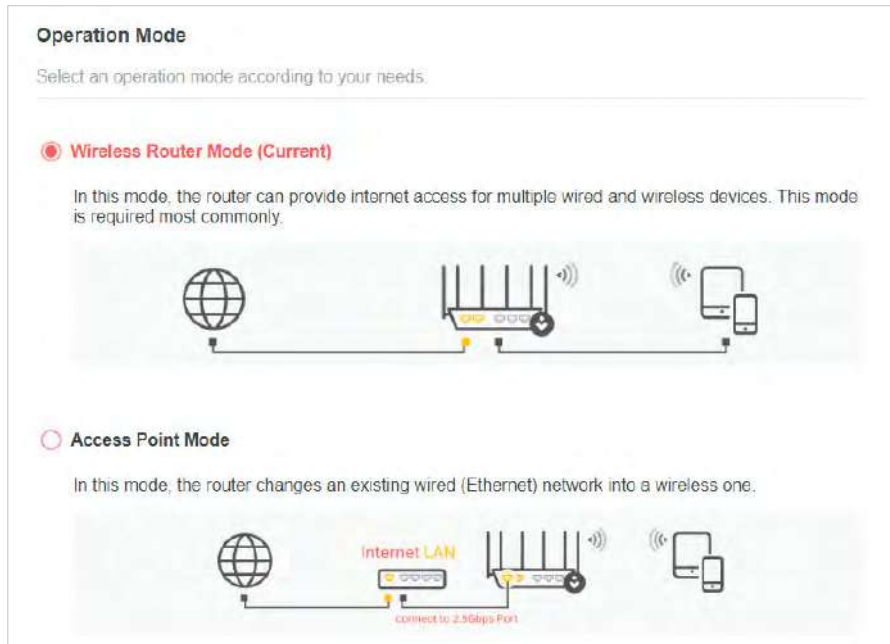

4.2. Quick Setup

1. Visit <http://mwlogin.net>, and log in with your Mercusys ID or the password you set for the router.
2. Go to **Advanced > Quick Setup**.
3. Follow the step-by-step instructions to complete the setup.

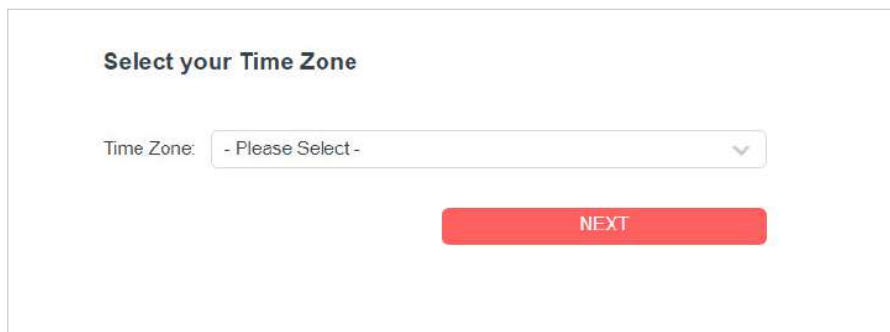

4.3. Network

4.3.1. Status

1. Visit <http://mwlogin.net>, and log in with password you set for the router.
2. Go to **Advanced > Network > Status**. You can view the current status information of the router.

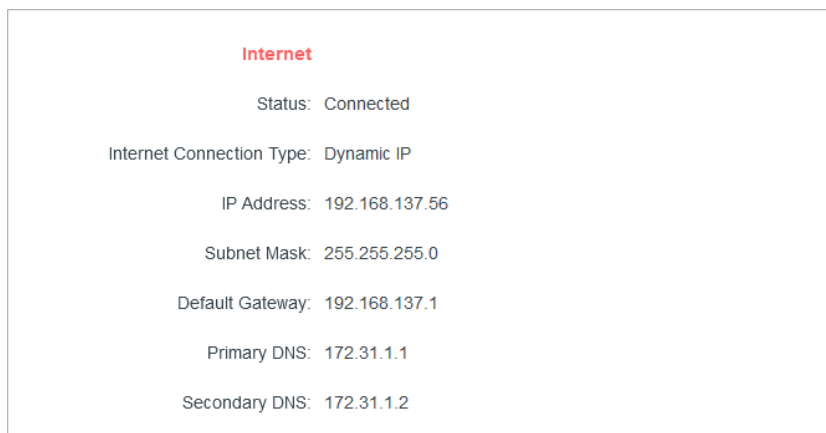

- **Internet** - This field displays the current settings of the internet, and you can configure them on the **Advanced > Network > Internet** page.
 - **Status** - Indicates whether the router has been connected to the internet.
 - **Internet Connection Type** - Indicates the way in which your router is connected to the internet.
 - **IP Address** - The WAN IP address of the router.
 - **Subnet Mask** - The subnet mask associated with the WAN IP address.
 - **Default Gateway** - The Gateway currently used is shown here.
 - **Primary & Secondary DNS** - The IP addresses of DNS (Domain Name System) server.

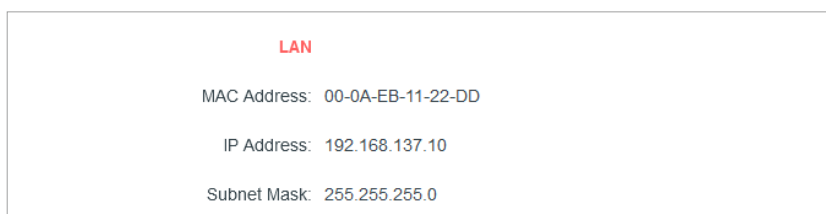

- **LAN** - This field displays the current settings of the LAN, and you can configure them on the **Advanced > Network > LAN** page.
 - **MAC Address** - The physical address of the router.
 - **IP Address** - The LAN IP address of the router.
 - **Subnet Mask** - The subnet mask associated with the LAN IP address.

<p>DHCP Server</p> <p>DHCP Server: Disabled</p>
<p>Dynamic DNS</p> <p>Service Provider: Mercusys</p>

- **DHCP Server** - This field displays the current settings of DHCP (Dynamic Host Configuration Protocol) Server, and you can configure them on the **Network > DHCP Server** page.
 - **DHCP Server** - Indicates whether the DHCP server is enabled or disabled. It is enabled by default and the router acts as a DHCP server.
 - **IP Address Pool** - The IP address range for the DHCP server to assign IP addresses.
- **Dynamic DNS** - This field displays the current settings of the Dynamic DNS (Domain Name System), and you can configure them on the **Advanced > Network > Dynamic DNS** page.
 - **Service Provider** - The Dynamic DNS service provider you have signed up for.

4.3.2. Internet

1. Visit <http://mwlogin.net>, and log in with your Mercusys ID or the password you set for the router.
2. Go to **Advanced > Network > Internet**.
3. Set up the internet connection and click **SAVE**.

Dynamic IP

If your ISP provides the DHCP service, please select **Dynamic IP**, and the router will automatically get IP parameters from your ISP.

Click **RENEW** to renew the IP parameters from your ISP.

Click **RELEASE** to release the IP parameters.

- **DNS Address** - The default setting is to get an IP address dynamically from your ISP. If your ISP does not automatically assign DNS addresses to the router, please select **Use the Following DNS Addresses** and enter the IP address in dotted-decimal notation of your ISP's primary DNS server. If a secondary DNS server address is available, enter it as well.
- **MTU Size** - The normal MTU (Maximum Transmission Unit) value for most Ethernet networks is 1500 Bytes. It is not recommended that you change the default MTU size unless required by your ISP.
- **Host Name** - This option specifies the name of the router.

- **Get IP with Unicast DHCP** - A few ISPs' DHCP servers do support the broadcast applications. If you cannot get the IP address normally, you can choose this option (it is rarely required).

Static IP

If your ISP provides a static or fixed IP address, subnet mask, default gateway and DNS setting, please select **Static IP**.

- **IP Address** - Enter the IP address in dotted-decimal notation provided by your ISP.
- **Subnet Mask** - Enter the subnet mask in dotted-decimal notation provided by your ISP. Normally 255.255.255.0 is used as the subnet mask.
- **Default Gateway** - Enter the gateway IP address in dotted-decimal notation provided by your ISP.
- **Primary/Secondary DNS** - (Optional) Enter one or two DNS addresses in dotted-decimal notation provided by your ISP.
- **MTU Size** - The normal MTU (Maximum Transmission Unit) value for most Ethernet networks is 1500 bytes. It is not recommended that you change the default MTU size unless required by your ISP.

PPPoE

If your ISP provides PPPoE connection, select **PPPoE**.

Internet

Set up an internet connection with the service information provided by your ISP (internet service provider).

Internet Connection Type:

Username:

Password:

IP Address: 1.1.1.2

Primary DNS: 1.1.1.1

Secondary DNS: 11.11.11.11

[▶ Advanced Settings](#)

- **Username/Password** - Enter the user name and password provided by your ISP. These fields are case-sensitive.
- **Secondary Connection** - It's available only for PPPoE connection. If your ISP provides an extra connection type, select **Dynamic IP** or **Static IP** to activate the secondary connection.
- **MTU Size** - The default MTU size is 1480 bytes. It is not recommended that you change the default MTU size unless required by your ISP.

- **Service Name** - The service name should not be configured unless you are sure it is necessary for your ISP. In most cases, leaving these fields blank will work.
- **Access Concentrator Name** - The access concentrator name should not be configured unless you are sure it is necessary for your ISP. In most cases, leaving these fields blank will work.
- **Detect Online Interval** - The router will detect Access Concentrator online at every interval. The default value is 10. You can input the value between 0 and 120. The value 0 means no detect.
- **IP Address** - The default setting is to get an IP address dynamically from your ISP. If your ISP does not automatically assign IP addresses to the router, please select **Use the Following IP Address** and enter the IP address provided by your ISP in dotted-decimal notation.
- **DNS Address** - The default setting is to get an IP address dynamically from your ISP. If your ISP does not automatically assign DNS addresses to the router, please select **Use the Following DNS Addresses** and enter the IP address in dotted-decimal notation of your ISP's primary DNS server. If a secondary DNS server address is available, enter it as well.
- **Connection Mode** - Select an appropriate connection mode that determines how to connect to the internet.
 - **Auto** - In this mode, the internet connection reconnects automatically any it gets disconnected.
 - **On Demand** - In this mode, the internet connection will be terminated automatically after a specified inactivity period (Max Idle Time) and be re-established when you attempt to access the internet again.
 - **Time-based** - In this mode, the internet connection is only established in a specific timeframe. If this option is selected, enter the start time and end time. Both are in HH:MM format.
 - **Manual** - In this mode, the internet connection is controlled manually by clicking the **Connect/Disconnect** button. This mode also supports the **Max Idle Time** function as **On Demand** mode. Enter a maximum time (in minutes), the internet connection can be inactive before it is terminated into the Max Idle Time. The default value is 15 minutes. If you want the internet connection remains active all the time, enter 0 (zero).

Note:

Sometimes the connection cannot be terminated although you have specified the **Max Idle Time** because some applications are visiting the internet continually in the background.

L2TP

If your ISP provides L2TP connection, please select **L2TP**.

Internet

Set up an internet connection with the service information provided by your ISP (internet service provider).

Internet Connection Type: L2TP

Username: 123

Password: ●●●

IP Address: 0.0.0.0

Primary DNS: 0.0.0.0

Secondary DNS: 0.0.0.0

Dynamic IP

Static IP

VPN Server IP/Domain Name: 123.com

IP Address: 0.0.0.0

Subnet Mask: 0.0.0.0

Default Gateway: 0.0.0.0

Primary DNS: 0.0.0.0

Secondary DNS: 0.0.0.0

MTU Size: 1460

The default is 1460, do not change unless necessary.

Connection Mode: Auto

CONNECT

DISCONNECT

- **Username/Password** - Enter the username and password provided by your ISP. These fields are case-sensitive.
- **VPN Server IP/ Domain Name** - Enter the VPN server's IP address or domain name provided by your ISP.
- **MTU Size** - The default MTU size is "1460" bytes, which is usually fine. It is not recommended that you change the default MTU Size unless required by your ISP.
- **Connection Mode**
 - **Auto** - In this mode, the internet connection reconnects automatically any it gets disconnected.
 - **On Demand** - In this mode, the internet connection will be terminated automatically after a specified inactivity period (Max Idle Time) and be re-established when you attempt to access the internet again.

- **Manual** - In this mode, the internet connection is controlled manually by clicking the **Connect/Disconnect** button. This mode also supports the **Max Idle Time** function as **On Demand** mode. Enter a maximum time (in minutes), the internet connection can be inactive before it is terminated into the Max Idle Time. The default value is 15 minutes. If you want the internet connection remains active all the time, enter 0 (zero).

Note:

Sometimes the connection cannot be terminated although you have specified the **Max Idle Time** because some applications are visiting the internet continually in the background.

PPTP

If your ISP provides PPTP connection, please select **PPTP**.

Internet

Set up an internet connection with the service information provided by your ISP (internet service provider).

Internet Connection Type:

Username:

Password:

IP Address: 0.0.0.0

Primary DNS: 0.0.0.0

Secondary DNS: 0.0.0.0

Dynamic IP
 Static IP

VPN Server IP/Domain Name:

IP Address: 0.0.0.0

Subnet Mask: 0.0.0.0

Default Gateway: 0.0.0.0

Primary DNS: 0.0.0.0

Secondary DNS: 0.0.0.0

MTU Size:
The default is 1420, do not change unless necessary.

Connection Mode:

- **Username/Password** - Enter the username and password provided by your ISP. These fields are case-sensitive.

- **VPN Server IP/ Domain Name** - Enter the VPN server's IP address or domain name provided by your ISP.
- **MTU Size** - The default MTU size is "1420" bytes, which is usually fine. It is not recommended that you change the default MTU Size unless required by your ISP.
- **Connection Mode**
 - **Auto** - In this mode, the internet connection reconnects automatically any it gets disconnected.
 - **On Demand** - In this mode, the internet connection will be terminated automatically after a specified inactivity period (Max Idle Time) and be re-established when you attempt to access the internet again.
 - **Manual** - In this mode, the internet connection is controlled manually by clicking the **Connect/Disconnect** button. This mode also supports the **Max Idle Time** function as **On Demand** mode. Enter a maximum time (in minutes), the internet connection can be inactive before it is terminated into the Max Idle Time. The default value is 15 minutes. If you want the internet connection remains active all the time, enter 0 (zero).

Note:

Sometimes the connection cannot be terminated although you have specified the **Max Idle Time** because some applications are visiting the internet continually in the background.

4.3.3. MAC Clone

1. Visit <http://mwlogin.net>, and log in with your Mercusys ID or the password you set for the router.
2. Go to **Advanced > Network > Internet** and locate the MAC Clone section.
3. Configure **Router MAC Address** and click **SAVE**.

The screenshot shows the 'MAC Clone' configuration page. The 'Router MAC Address:' field has a dropdown menu with 'Clone Current Device MAC' selected. Below the dropdown, there are three options: 'Use Default MAC Address', 'Clone Current Device MAC' (highlighted in red), and 'Use Custom MAC Address'. At the bottom left of the form, the 'NAT' section is partially visible.

- **Use Default MAC Address** - Do not change the default MAC address of your router in case the ISP does not bind the assigned IP address to the MAC address.

- **Use Current MAC Address** - Select to copy the current MAC address of the computer that is connected to the router, in case the ISP binds the assigned IP address to the MAC address.
- **Use Custom MAC Address** - Select if your ISP requires you to register the MAC address and enter the correct MAC address in this field, in case the ISP binds the assigned IP address to the specific MAC address.

Note:

- You can only use the MAC Address Clone function for PCs on the LAN.
- If you have changed the WAN MAC address when the WAN connection is PPPoE, it will not take effect until the connection is re-established.

4.3.4. NAT

The router's NAT (Network Address Translation) feature makes devices on the LAN use the same public IP address to communicate with devices on the internet, which protects the local network by hiding IP addresses of the devices.

1. Visit <http://mwlogin.net>, and log in with your Mercusys ID or the password you set for the router.
2. Go to **Advanced > Network > Internet** and locate the **NAT** section.
3. Configure **NAT**, then click **SAVE**.

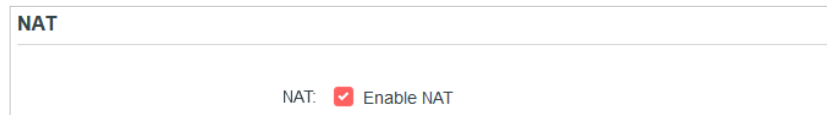

The screenshot shows a web interface for NAT configuration. At the top, the word 'NAT' is displayed. Below it, there is a checkbox labeled 'NAT:' which is checked, followed by the text 'Enable NAT'.

4. NAT is enable by dafault and it's highly recommended. If you disable it, you may have no access to the internet and NAT Forwarding will not take effect.

4.3.5. Internet Port Negotiation Speed Setting

1. Visit <http://mwlogin.net>, and log in with your Mercusys ID or the password you set for the router.
2. Go to **Advanced > Network > Internet** and locate the **Internet Port Negotiation Speed Setting** section.
3. Select the duplex type from the drop-down list and click **SAVE**.

Internet Port Negotiation Speed Setting



The screenshot shows the 'Internet Port Negotiation Speed Setting' section. It features a label 'Internet Port Negotiation Speed Setting:' followed by a dropdown menu currently displaying 'Auto Negotiation' with a downward arrow.

4.3.6. LAN

1. Visit <http://mwlogin.net>, and log in with your Mercusys ID or the password you set for the router.
2. Go to **Advanced > Network > LAN**.
3. Configure the IP parameters of the LAN and click **SAVE**.

LAN

View and configure LAN settings.

MAC Address: 88-CD-04-81-92-55

IP Address:

Subnet Mask: ▼

- **MAC Address** - The physical address of the LAN ports. The value can not be changed.
- **IP Address** - Enter the IP address in dotted-decimal notation of your router (the default one is 192.168.1.1).
- **Subnet Mask** - An address code that determines the size of the network. Normally 255.255.255.0 is used as the subnet mask.

Note:

- If you have changed the IP address, you must use the new IP address to log in.
- If the new IP address you set is not in the same subnet as the old one, the IP address pool in the DHCP Server will be configured automatically, but the Virtual Server and DMZ Host will not take effect until they are re-configured.

4.3.7. IPTV/VLAN

1. Visit <http://mwlogin.net>, and log in with your Mercusys ID or the password you set for the router.
2. Go to **Advanced > Network > IPTV/VLAN**.
3. Configure IPTV/VLAN settings if you want to enjoy IPTV or VoIP service, or if your ISP requires VLAN tags.

IPTV/VLAN

Configure IPTV/VLAN settings if you want to enjoy IPTV or VoIP service, or if your ISP requires VLAN tags.

IPTV/VLAN: Enable

Mode: Bridge

LAN1: Internet

LAN2: Internet

1Gbps LAN: IPTV

- **IPTV/VLAN** - Select to enable the IPTV feature.
- **Mode** - Select the appropriate mode according to your ISP.
- **LAN 1/LAN2** - Assign your LAN port to whether function as the internet supplier or as the IPTV supplier.

4.3.8. Multicast

1. Visit <http://mwlogin.net>, and log in with your Mercusys ID or the password you set for the router.
2. Go to **Advanced > Network > IPTV/VLAN**, and locate the **Multicast** section.
3. View the Multicast settings. It is recommended to keep them as default.

Multicast

Check the multicast settings. It is recommended to keep them as default.

IGMP Proxy: Enable

IGMP Snooping: Enable

IGMP Version: V2

4.3.9. DHCP Server

By default, the DHCP (Dynamic Host Configuration Protocol) Server is enabled and the router acts as a DHCP server; it dynamically assigns TCP/IP parameters to client devices from the IP Address Pool. You can change the settings of DHCP Server if necessary, and you can reserve LAN IP addresses for specified client devices.

- **To specify the IP address that the router assigns:**

1. Visit <http://mwlogin.net>, and log in with your Mercusys ID or the password you set for the router.
2. Go to **Advanced > Network > DHCP Server** and locate the DHCP Server section.

DHCP Server
Dynamically assign IP addresses to the devices connected to the router.

DHCP Server: Enable

IP Address Pool: 192.168.137.100 - 192.168.137.199

Address Lease Time: 120 minutes

Default Gateway: 192.168.137.200 (Optional)

Primary DNS: 172.31.1.1 (Optional)

Secondary DNS: 172.31.1.2 (Optional)

1. Tick the **Enable** checkbox.
2. Enter the starting and ending IP addresses in the **IP Address Pool**.
3. Enter other parameters if the ISP offers. The **Default Gateway** is automatically filled in and is the same as the LAN IP address of the router.
4. Click **SAVE**.

Note:

To use the DHCP server function of the router, you must configure all computers on the LAN as Obtain an IP Address automatically.

- **To reserve an IP address for a specified client device:**

1. Visit <http://mwlogin.net>, and log in with your Mercusys ID or the password you set for the router.
2. Go to **Advanced > Network > DHCP Server** and locate the **Address Reservation** section.
3. Click **Add** in the **Address Reservation** section.

Address Reservation
Reserve IP addresses for specific devices connected to the router.

[+ Add](#)

Device Name	MAC Address	Reserved IP Address	Status	Modify
No Entries in this table				

4. Click **VIEW CONNECTED DEVICES** and select the you device you want to reserve an IP for. Then the **MAC and IP Address** will be automatically filled in. You can also enter the **MAC and IP address** of the client device.

Add a Reservation Entry

MAC Address:

[VIEW CONNECTED DEVICES](#)

IP Address:

[CANCEL](#) [SAVE](#)

- **To check the DHCP client list:**

1. Visit <http://mwlogin.net>, and log in with your Mercusys ID or the password you set for the router.
2. Go to **Advanced > Network > DHCP Server** and locate the **DHCP Client List** section. You can see the device information of the list.
3. Click **Refresh** to see the current attached devices.

DHCP Client List

View the devices that are currently assigned with IP addresses by the DHCP server.

Total Clients: 66 [Refresh](#)

Device Name	MAC Address	Assigned IP Address	Lease Time
[redacted]-PC	40-8D-5C-69-BD-B8	192.168.1.100	01:55:42

4.3.10. Dynamic DNS

The router offers the DDNS (Dynamic Domain Name System) feature, which allows the hosting of a website, FTP server, or e-mail server with a fixed domain name (named by yourself) and a dynamic IP address. Thus your friends can connect to your server by entering your domain name no matter what your IP address is.

Before using this feature, you need to sign up for DDNS service providers. The Dynamic DNS client service provider will give you a password or key.

1. Visit <http://mwlogin.net>, and log in with the username and password you set for the router.
2. Go to **Advanced > Network > Dynamic DNS**.
3. Select the **DDNS Service Provider**: Mercusys, NO-IP or DynDNS.

It is recommended to select Mercusys so that you can enjoy superior DDNS service of Mercusys. To use Mercusys DDNS service, log in with your Mercusys ID and register new domain names.

Dynamic DNS

Assign a fixed host name (domain name) for remote access to your device, website, or server behind the router.

Service Provider:

Current Domain Name:

Domain Name List

[+ Register](#)

Domain Name	Registered Date	Status	Operation	Delete
No Entries				

If you have selected NO-IP or DynDNS, enter the username, password and domain name of your account. If you don't have a DDNS account, register first by clicking **Register Now**. Note: If your service provider is NO-IP, select **WAN IP binding** to ensure that the domain name is bound to the WAN IP of this router.

Dynamic DNS

Assign a fixed host name (domain name) for remote access to your device, website, or server behind the router.

Service Provider: [Register Now](#)

Username:

Password:

Domain Name:

Status: Connecting...

[LOGIN AND SAVE](#)

[LOGOUT](#)

4.3.11. Static Routing

Static Routing is a form of routing that is configured manually by a network administrator or a user by adding entries into a routing table. The manually-configured routing information guides the router in forwarding data packets to the specific destination.

I want to:

Visit multiple networks and servers at the same time.

For example, in a small office, my PC can surf the internet through Router A, but I also want to visit my company's network. Now I have a switch and Router B. I connect the devices

as shown in the following figure so that the physical connection between my PC and my company's server is established. To surf the internet and visit my company's network at the same time, I need to configure the static routing.

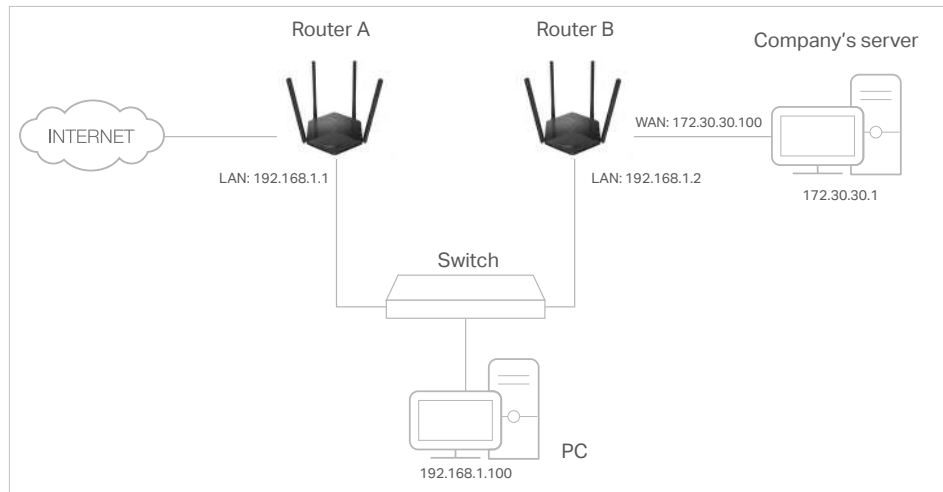

How can I do that?

1. Change the routers' LAN IP addresses to two different IP addresses on the same subnet. Disable Router B's DHCP function.
1. Visit <http://mwlogin.net>, and log in with your Mercusys ID or the password you set for Router A.
2. Go to **Advanced > Network > Routing** and locate the Static Routing section.
3. Click **Add** and finish the settings according to the following explanations:

✕
Add a Routing Entry

Network Destination:

Subnet Mask:

Default Gateway:

Interface: WAN ▼

Description:

CANCEL
SAVE

- **Network Destination** - The destination IP address that you want to assign to a static route. This IP address cannot be on the same subnet with the WAN IP or LAN IP of Router A. In the example, the IP address of the company network is the destination IP address, so here enter 172.30.30.1.

- **Subnet Mask** - The Subnet Mask determines which portion of an IP address is the network portion, and which portion is the host portion.
 - **Default Gateway** - The IP address of the gateway device to which the data packets will be sent. This IP address must be on the same subnet with the router's IP which sends out data. In the example, the data packets will be sent to the LAN port of Router B and then to the Server, so the default gateway should be 192.168.1.2.
 - **Interface** - Determined by the port (WAN/LAN) that sends out data packets. In the example, the data are sent to the gateway through the LAN port of Router A, so **LAN** should be selected.
 - **Description** - Enter a description for this static routing entry.
4. Click **SAVE**.
 5. Check the **Routing Table** below. If you can find the entry you've set, the static routing is set successfully.

4.4. Mercusys ID

1. Visit <http://mwlogin.net>, and log in with your Mercusys ID or the password you set for the router.
2. Go to **Advanced > Mercusys ID**.

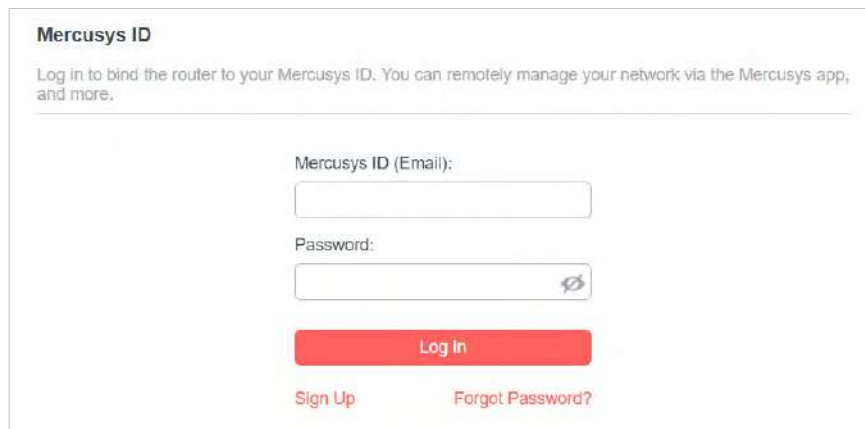

Mercusys ID

Log in to bind the router to your Mercusys ID. You can remotely manage your network via the Mercusys app, and more.

Mercusys ID (Email):

Password:

Log In

[Sign Up](#) [Forgot Password?](#)

3. Log in with your Mercusys ID. You can manage the account information and bind more accounts to manage the network.

Note: If you don't have an account, sign up first.

Mercusys ID

Log in to bind the router to your Mercusys ID. You can remotely manage your network via the Mercusys app, and more.

Account Information

Email: [redacted] 



Password: [redacted] 

Device Information

Model: MR [redacted]

Status: Being managed by [redacted] 

Bound Accounts

 Bind  Unbind

<input type="checkbox"/>	ID	Email	Binding Date	Role
<input type="checkbox"/>	1	[redacted]	10/27/2022	Admin

4.5. Wireless

4.5.1. Wireless Settings

1. Visit <http://mwlogin.net>, and log in with your Mercusys ID or the password you set for the router.
2. Go to **Advanced > Wireless > Wireless Settings**.
3. Configure the wireless settings for the wireless network and click **SAVE**.

The screenshot displays the wireless configuration page for a router. It is divided into two main sections for 2.4GHz and 5GHz bands. At the top, there are three global settings: OFDMA (unchecked), TWT (unchecked), and Smart Connect (unchecked). The 2.4GHz section is enabled and labeled 'Sharing Network'. Its settings include: Network Name (SSID) 'MERCUSYS_CEE0', Security 'WPA2-PSK[AES]', Password '15176943', Transmit Power 'High', Channel Width '20/40MHz', Channel 'Auto', and Mode '802.11b/g/n mixed'. The 5GHz section is also enabled and labeled 'Sharing Network'. Its settings include: Network Name (SSID) 'MERCUSYS_CEE0_5G', Security 'WPA2-PSK[AES]', Password '15176943', Transmit Power 'High', Channel Width '20/40/80MHz', Channel 'Auto', and Mode '802.11a/n/ac/ax mixed'. At the bottom, MU-MIMO is checked and enabled.

- **OFDMA** - This feature enables multiple users to transmit data simultaneously, and thus greatly improves speed and efficiency. Noted that only when your clients also support OFDMA, can you fully enjoy the benefits.
- **TWT** - Target Wake Time allows 802.11ax routers and clients to negotiate their periods to transmit and receive data packets. Clients only wake up at TWT sessions and remain in sleep mode for the rest of the time, which significantly extend their battery life.
- **Smart Connect** - This feature allows each of the router's wireless bands to use the same wireless settings. The router can balance network demand and assign devices to the optimum band.
- **2.4GHz/5GHz** - Select this checkbox to enable the 2.4GHz/5GHz wireless network.
- **Network Name (SSID)** - Enter a value of up to 32 characters. The same Name (SSID) must be assigned to all wireless devices in your network.

- **Hide SSID** - Select this checkbox if you want to hide the 2.4GHz network name (SSID) from the Wi-Fi network list. In this case, you need to manually join the network.
- **Security** - Select an option from the Security drop-down list. We recommend you keep the default settings.
- **Password** - Set the password for the wireless network.
- **Transmit Power** - Select **High**, **Middle** or **Low** to specify the data transmit power. The default and recommended setting is **High**.
- **Channel Width** - Select a channel width (bandwidth) for the wireless network.
- **Channel** - Select an operating channel for the wireless network. It is recommended to leave the channel to **Auto**, if you are not experiencing the intermittent wireless connection issue.
- **Mode** - You can choose the appropriate "Mixed" mode.
- **MU-MIMO** - This feature enables the router to simultaneously send data to multiple devices, significantly enhancing the network efficiency.

4.5.2. Guest Network

Guest Network allows you to provide Wi-Fi access for guests without disclosing your host network. When you have guests in your house, apartment, or workplace, you can create a guest network for them. In addition, you can customize guest network settings to ensure network security and privacy.

• Create a Guest Network

1. Visit <http://mwlogin.net>, and log in with your Mercusys ID or the password you set for the router.
2. Go to Wireless or **Advanced > Wireless > Guest Network**.
3. Enable the 2.4GHz and/or 5GHz guest network according to your needs.

Guest Network

Enable the wireless bands you want your guests to use and complete the related information.

2.4GHz: Enable Sharing Network

Network Name (SSID): Hide SSID

5GHz: Enable Sharing Network

Network Name (SSID): Hide SSID

Security:

Password:

4. Create a network name for your guest network.

5. Select the **Security** type and create the **Password** of the guest network.
6. Click **SAVE**. Now you guests can access your guest network using the SSID and password you set!

- **Customize Guest Network Options**

1. Visit <http://mwlogin.net>, and log in with your Mercusys ID or the password you set for the router.
2. Go to **Advanced > Wireless > Guest Network**. Locate the **Guest Permissions** section.
3. Customize guest network options according to your needs.

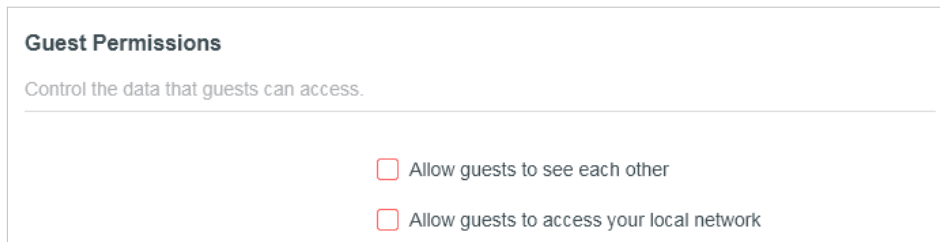

Guest Permissions

Control the data that guests can access.

Allow guests to see each other

Allow guests to access your local network

- **Allow guests to see each other**

Tick this checkbox if you want to allow the wireless clients on your guest network to communicate with each other via methods such as network neighbors and Ping.

- **Allow guests to access my local network**

Tick this checkbox if you want to allow the wireless clients on your guest network to communicate with the devices connected to your router's LAN ports or main network via methods such as network neighbors and Ping.

4. Click **SAVE**. Now you can ensure network security and privacy!

4.5.3. Wireless Schedule

The wireless function can be automatically off at a specific time when you do not need the wireless function.

1. Visit <http://mwlogin.net>, and log in with your Mercusys ID or the password you set for the router.
2. Go to **Advanced > Wireless > Wireless Schedule**.
3. Enable the **Wireless Schedule** function.

4. Click **Add** to specify a wireless off period during which you need the wireless off automatically, and click **SAVE**.

Note:

- The effective wireless schedule is based on the time of the router. You can go to **Advanced > System > Time** to modify the time.
- The wireless network will be automatically turned on after the time period you set.

4.5.4. WPS

WPS (Wi-Fi Protected Setup) can help you to quickly and securely connect to a network. This section will guide you to add a new wireless device to your router's network quickly via WPS.

Note:

The WPS function cannot be configured if the wireless function of the router is disabled. Please make sure the wireless function is enabled before configuration.

1. Visit <http://mwlogin.net>, and log in with your Mercusys ID or the password you set for the router.
2. Go to **Advanced > Wireless > WPS**.

- Follow one of the following methods to connect your client device to the router's Wi-Fi network.

Method 1: Using a PIN

• Connects via the Client's PIN

- Keep the WPS Status as **Enabled** and select **Client's PIN**.

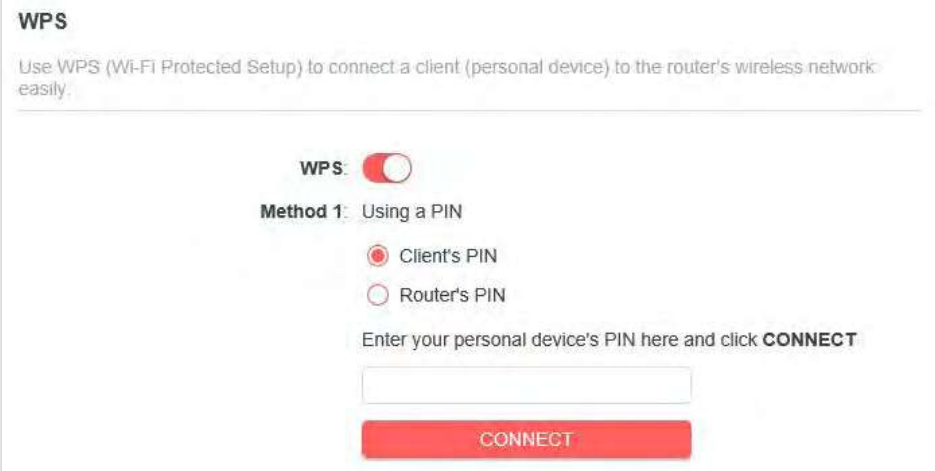

WPS

Use WPS (Wi-Fi Protected Setup) to connect a client (personal device) to the router's wireless network easily.

WPS:

Method 1: Using a PIN

Client's PIN

Router's PIN

Enter your personal device's PIN here and click **CONNECT**

CONNECT

- Enter the PIN of your device and click **CONNECT**. Then your device will get connected to the router.

• Connects via the Router's PIN

- Keep the WPS Status as **Enabled** and select **Router's PIN**.

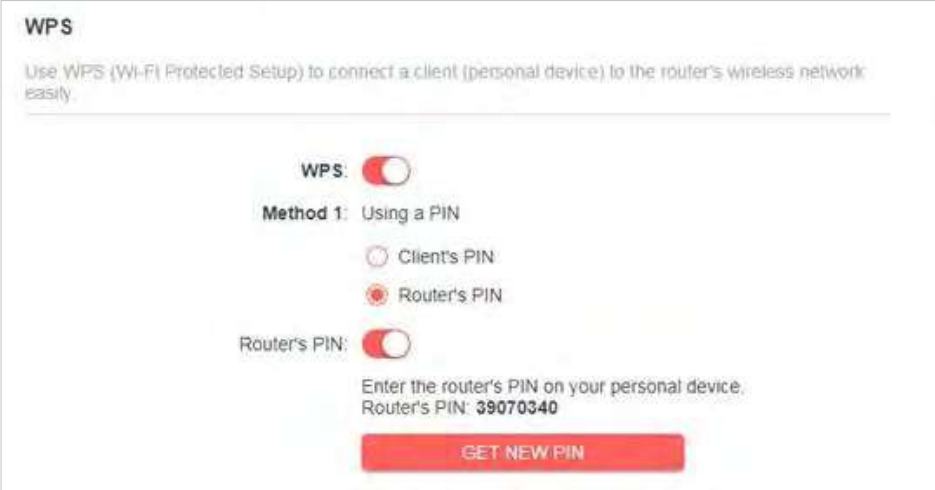

WPS

Use WPS (Wi-Fi Protected Setup) to connect a client (personal device) to the router's wireless network easily.

WPS:

Method 1: Using a PIN

Client's PIN

Router's PIN

Router's PIN:

Enter the router's PIN on your personal device.
Router's PIN: **39070340**

GET NEW PIN

- Enter the router's PIN on your personal device. You can also generate a new one.

Note:

PIN (Personal Identification Number) is an eight-character identification number preset to each router. WPS supported devices can connect to your router with the PIN.

Method 2: Using the WPS Button on the Web Screen

Click **Start** on the screen. Within two minutes, enable WPS on your personal device. A **Device-(XX-XX-XX-XX-XX-XX) Connected** message should appear on the screen, indicating successful WPS connection.

Note:

XX-XX-XX-XX-XX-XX is the MAC address of your device.

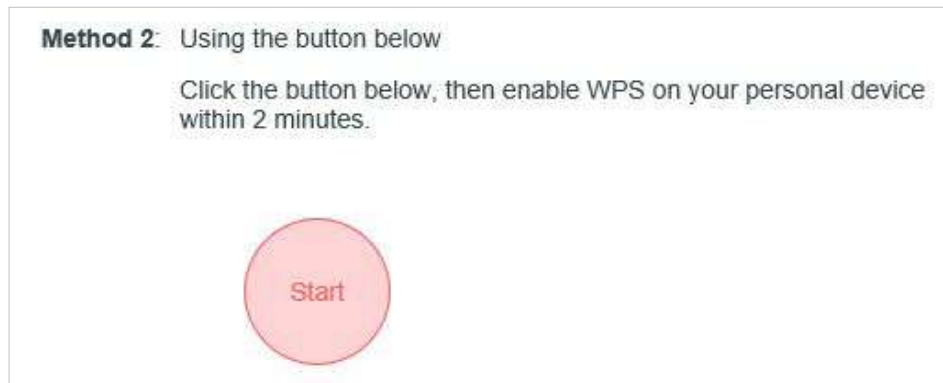

Method 3: Using the WPS Button on the Router

Press the router's WPS button. Within two minutes, enable WPS on your personal device.



4.5.5. Additional Settings

1. Visit <http://mwlogin.net>, and log in with your Mercusys ID or the password you set for the router.
2. Go to **Advanced > Wireless > Additional Settings**.
3. Configure the advanced settings of your wireless network and click **SAVE**.

Note:

If you are not familiar with the setting items on this page, it's strongly recommended to keep the provided default values; otherwise it may result in lower wireless network performance.

Additional Settings

Check advanced wireless settings for your device.

WMM: Enable

AP Isolation: Enable

Airtime Fairness: Enable

Beacon Interval:

RTS Threshold:

DTIM Interval:

Group Key Update Period: s

- **WMM** - WMM function can guarantee the packets with high-priority messages being transmitted preferentially.
- **AP Isolation** - This function isolates all connected wireless stations so that wireless stations cannot access each other through WLAN.
- **Airtime Fairness** - This function can improve the overall network performance by sacrificing a little bit of network time on your slow devices.
- **Beacon Interval** - Enter a value between 40-1000 milliseconds for Beacon Interval here. Beacon Interval value determines the time interval of the beacons. The beacons are the packets sent by the router to synchronize a wireless network. The default value is 100.
- **RTS Threshold** - Here you can specify the RTS (Request to Send) Threshold. If the packet is larger than the specified RTS Threshold size, the router will send RTS frames to a particular receiving station and negotiate the sending of a data frame. The default value is 2346.
- **DTIM Interval** - This value determines the interval of the Delivery Traffic Indication Message (DTIM). A DTIM field is a countdown field informing clients of the next window for listening to broadcast and multicast messages. When the router has buffered broadcast or multicast messages for associated clients, it sends the next DTIM with a DTIM Interval value. You can specify the value between 1-255 Beacon Intervals. The default value is 1, which indicates the DTIM Interval is the same as Beacon Interval.
- **Group Key Update Period** - Enter a number of seconds (minimum 30) to control the time interval for the encryption key automatic renewal. The default value is 0, meaning no key renewal.

4. 6. NAT Forwarding

The router's NAT (Network Address Translation) feature makes the devices on the LAN use the same public IP address to communicate on the internet, which protects the local

network by hiding IP addresses of the devices. However, it also brings about the problem that external hosts cannot initiatively communicate with the specified devices in the local network.

With the forwarding feature, the router can traverse the isolation of NAT so that clients on the internet can reach devices on the LAN and realize some specific functions.

The Mercusys router includes four forwarding rules. If two or more rules are set, the priority of implementation from high to low is Port Forwarding, Port Triggering, UPNP and DMZ.

4.6.1. Port Forwarding

When you build up a server in the local network and want to share it on the internet, Port Forwarding can realize the service and provide it to internet users. At the same time Port Forwarding can keep the local network safe as other services are still invisible from the internet.

Port Forwarding can be used to set up public services in your local network, such as HTTP, FTP, DNS, POP3/SMTP and Telnet. Different service uses different service port. Port 80 is used in HTTP service, port 21 in FTP service, port 25 in SMTP service and port 110 in POP3 service. Please verify the service port number before the configuration.

I want to:

Share my personal website I've built in local network with my friends through the internet.

For example, the personal website has been built in my home PC (192.168.1.100). I hope that my friends on the internet can visit my website in some way. My PC is connected to the router with the WAN IP address 218.18.232.154.

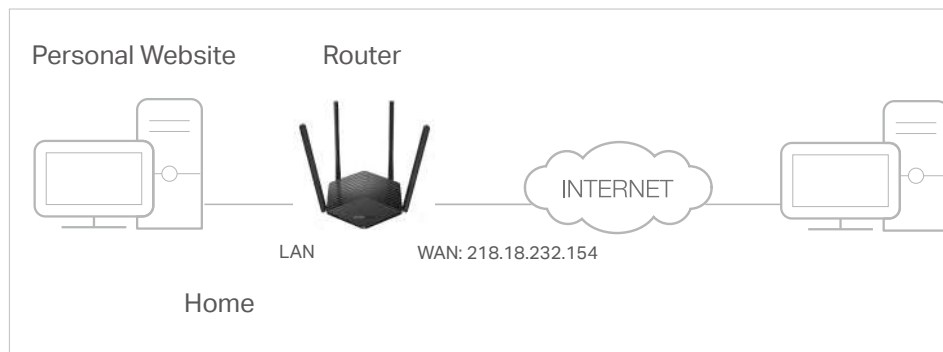

1. Set your PC to a static IP address, for example 192.168.1.100.
2. Visit <http://mwlogin.net>, and log in with your Mercusys ID or the password you set for the router.
3. Go to **Advanced > NAT Forwarding > Port Forwarding**.
4. Click **Add**.

1. Click **VIEW COMMON SERVICES** and select **HTTP**. The **External Port**, **Internal Port** and **Protocol** will be automatically filled in.
 2. Click **VIEW CONNECTED DEVICES** and select your home PC. The **Device IP Address** will be automatically filled in. Or enter the PC's IP address 192.168.1.100 manually in the **Device IP Address** field.
2. Click **SAVE**.

Note:

- It is recommended to keep the default settings of **Internal Port** and **Protocol** if you are not clear about which port and protocol to use.
- If the service you want to use is not in the **Common Services** list, you can enter the corresponding parameters manually. You should verify the port number that the service needs.
- You can add multiple virtual server rules if you want to provide several services in a router. Please note that the **External Port** should not be overlapped.

Done!

Users on the internet can enter **http:// WAN IP** (in this example: **http:// 218.18.232.154**) to visit your personal website.

Note:

- If you have changed the default **External Port**, you should use **http:// WAN IP: External Port** to visit the website.
- The WAN IP should be a public IP address. For the WAN IP is assigned dynamically by the ISP, it is recommended to apply and register a domain name for the WAN referring to **Dynamic DNS**. Then users on the internet can use **http:// domain name** to visit the website.

4. 6. 2. Port Triggering

Port triggering can specify a triggering port and its corresponding external ports. When a host in the local network initiates a connection to the triggering port, all the external ports will be opened for subsequent connections. The router can record the IP address of the

host. When the data from the internet return to the external ports, the router can forward them to the corresponding host. Port triggering is mainly applied to online games, VoIPs, video players and common applications including MSN Gaming Zone, Dialpad, Quick Time 4 players and more.

Follow the steps below to configure the port triggering rules:

1. Visit <http://mwlogin.net>, and log in with your Mercusys ID or the password you set for the router.
2. Go to **Advanced > NAT Forwarding > Port Triggering**.
3. Click **Add**.
4. Click **VIEW COMMON SERVICES**, and select the desired application. The Triggering Port, Triggering Protocol and External Port will be automatically filled in. The following picture takes application MSN Gaming Zone as an example.

The screenshot shows a dialog box titled "Add a Port Triggering Entry" with a close button (X) in the top right corner. The dialog contains the following fields and controls:

- Service Name:** A text input field containing "MSN Gaming Zone".
- VIEW COMMON SERVICES:** A red button located below the Service Name field.
- Triggering Port:** A text input field containing "47624".
- Triggering Protocol:** A dropdown menu with "All" selected.
- External Port:** A text input field containing "2300-2400,28800-29000". Below this field is a note: "(XX or XX-XX, 1-65535, at most 5 pairs)".
- External Protocol:** A dropdown menu with "All" selected.
- Enable This Entry:** A checkbox that is checked.
- CANCEL:** A light gray button at the bottom left.
- SAVE:** A red button at the bottom right.

5. Click **SAVE**.

Note:

- You can add multiple port triggering rules as needed.
- The triggering ports can not be overlapped.
- If the application you need is not listed in the Common Services list, please enter the parameters manually. You should verify the external ports the application uses first and enter them in External Ports field. You can input at most 5 groups of ports (or port sections). Every group of ports must be set apart with ",". For example, 2000-2038, 2050-2051, 2085, 3010-3030.

4.6.3. UPnP

The UPnP (Universal Plug and Play) protocol allows the applications or host devices to automatically find the front-end NAT device and send request to it to open the corresponding ports. With UPnP enabled, the applications or host devices on the local

network and the internet can freely communicate with each other realizing the seamless connection of the network. You may need to enable the UPnP if you want to use applications for multiplayer gaming, peer-to-peer connections, real-time communication (such as VoIP or telephone conference) or remote assistance, etc.

Tips:

- UPnP is enabled by default in this router.
- Only the application supporting UPnP protocol can use this feature.
- UPnP feature needs the support of operating system (e.g. Windows Vista/ Windows 7/ Windows 8, etc. Some of operating system need to install the UPnP components).

For example, when you connect your Xbox to the router which is connected to the internet to play online games, UPnP will send request to the router to open the corresponding ports allowing the following data penetrating the NAT to transmit. Therefore, you can play Xbox online games without a hitch.

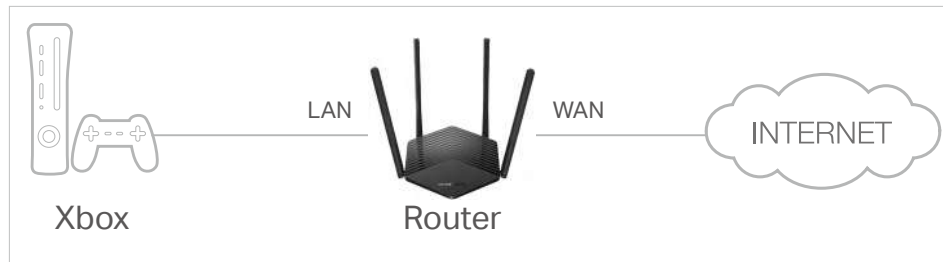

If necessary, you can follow the steps to change the status of UPnP.

1. Visit <http://mwlogin.net>, and log in with your Mercusys ID or the password you set for the router.
2. Go to **Advanced > NAT Forwarding > UPnP** and toggle on or off according to your needs.

UPnP

Enable UPnP (Universal Plug and Play) to allow devices on your local network to dynamically open ports for applications such as multiplayer gaming and real-time communications.

UPnP:

UPnP Client List

Displays the UPnP device information.

Total Clients: 2 Refresh

Service Description	Client IP Address	Internal Port	External Port	Protocol
ms	192.168.0.14	20	10	TCP
gmp	192.168.0.14	70	20	UDP

4.6.4. DMZ

When a PC is set to be a DMZ (Demilitarized Zone) host in the local network, it is totally exposed to the internet, which can realize the unlimited bidirectional communication between internal hosts and external hosts. The DMZ host becomes a virtual server with all ports opened. When you are not clear about which ports to open in some special applications, such as IP camera and database software, you can set the PC to be a DMZ host.

Note:

DMZ is more applicable in the situation that users are not clear about which ports to open. When it is enabled, the DMZ host is totally exposed to the internet, which may bring some potential safety hazards. If DMZ is not in use, please disable it in time.

I want to:

Make the home PC join the internet online game without port restriction.

For example, due to some port restriction, when playing the online games, you can log in normally but cannot join a team with other players. To solve this problem, set your PC as a DMZ host with all ports opened.

How can I do that?

1. Assign a static IP address to your PC, for example 192.168.1.100.
3. Visit <http://mwlogin.net>, and log in with your Mercusys ID or the password you set for the router.
2. Go to **Advanced > NAT Forwarding > DMZ** and select **Enable DMZ**.
3. Click **VIEW CONNECTED DEVICES** and select your PC. The DMZ Host IP Address will be automatically filled in. Or enter the PC's IP address 192.168.1.100 manually in the DMZ Host IP Address field.

DMZ

Expose a specific device in your local network to the internet for applications such as online gaming and real-time communications.

DMZ: Enable

DMZ Host IP Address:

VIEW CONNECTED DEVICES

4. Click **SAVE**.

Done!

You've set your PC to a DMZ host and now you can make a team to game with other players.

4.7. Parental Controls

Parental Controls allows you to set up unique restrictions on internet access for each member of your family. You can block inappropriate content, set daily limits for the total time spent online and restrict internet access to certain times of the day.

I want to:

Block access to inappropriate online content for my child's devices, restrict internet access to 2 hours every day and block internet access during bed time (10 PM to 7 AM) on weekdays.

How can I do that?

1. Visit <http://mwlogin.net>, and log in with your Mercusys ID or the password you set for the router.
2. Go to **Advanced > Parental Controls**.
3. Click **Add** to create a profile for a family member.

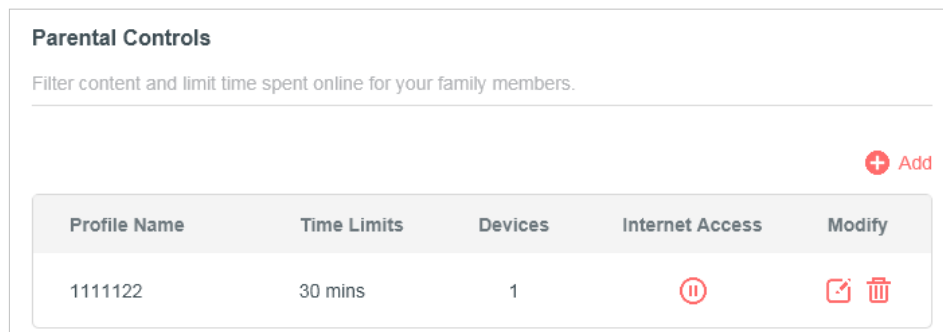

4. Add basic profile information.

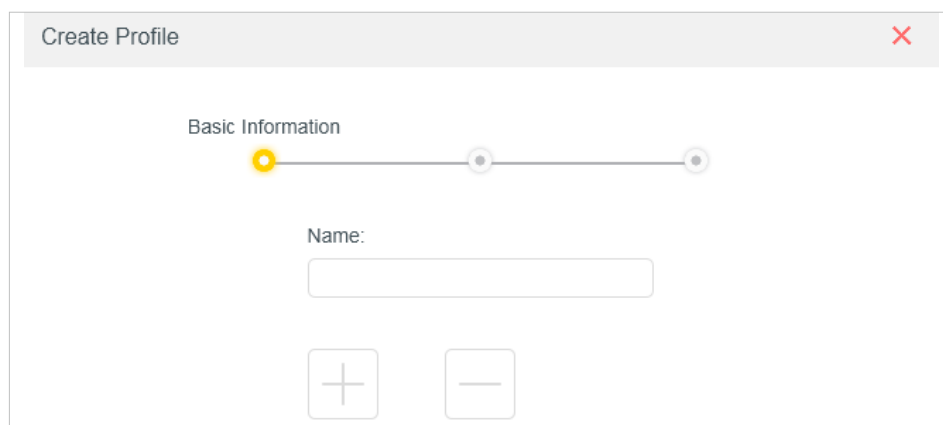

- 1) Enter a Name for the profile to make it easier to identify.
- 2) Under Devices, click .
- 3) Select the devices that belong to this family member. Access restrictions will be applied to these devices. Click **ADD** when finished.

Note: Only devices that have previously been connected to your router's network are listed here. If you are unable to find the device you want to add, connect it to your network and then try again.

4) Click **NEXT**.

5. Block content for this profile.

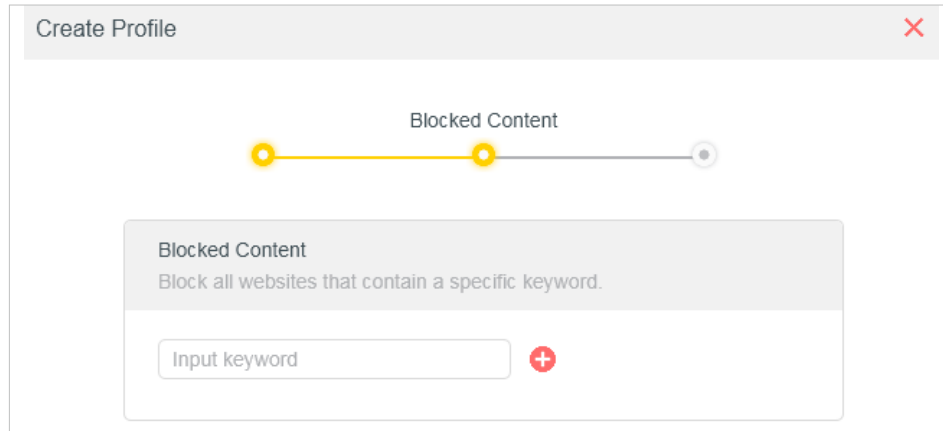

1) Enter the key word of the website that you want to block. Click **+** if want to block multiple websites.

2) Click **NEXT**.

5. Set time restrictions on internet access.

Create Profile

Time Controls

Time Limits

Set daily time limits for the total time spent online:

Mon to Fri:

Daily Time Limit: 2 hours

Sat & Sun:

Daily Time Limit: 2 hours

Bed Time

Block this person's internet access between certain times.

School Nights:
(Sun to Thur)

Good Night: 22 : 00

Good Morning: 07 : 00

Weekend:
(Fri & Sat)

- 1) Enable **Time Limits** on Monday to Friday and Saturday & Sunday then set the allowed online time to 2 hours each day.
- 2) Enable **Bed Time** on School Nights (Sun to Thur) and use the up/down arrows or enter times in the fields. Devices under this profile will be unable to access the internet during this time period.
- 3) Click **SAVE**.

Note: The effective time limits are based on the time of the router. You can go to **Advanced > System > Time** to modify the time.

Done!

The amount of time your child spends online is controlled and inappropriate content is blocked on their devices.

4. 8. QoS

QoS (Quality of Service) is designed to ensure the efficient operation of the network when come across network overload or congestion. Devices set as high priority will be allocated more bandwidth and so continue to run smoothly even when there are many devices connected to the network.

I want to:

Ensure a fast connection of my computer while I play online games for the next 2 hours.

How can I do that

1. Visit <http://mwlogin.net>, and log in with your Mercusys ID or the password you set for the router.
2. Go to **Advanced > QoS**.
3. Tick the **Enable** checkbox of QoS.
4. Enter the maximum upload and download bandwidths provided by your internet service provider, and then click **SAVE**. 1Mbps equals to 1,000Kbps.
5. Find your computer in the **Device Priority** section and toggle on **Priority**. Select 4 hours from the drop-down list of **Timing**. Your computer will be prioritized for the next 4 hours.

Global Settings

Prioritize the internet traffic of specific devices to guarantee a faster connection. You need to set the total bandwidth before using QoS.

QoS: Enable

Upload Bandwidth:

Download Bandwidth:

Device Priority

Type	Information	Real-time Rate	Traffic Usage	Priority	Timing
	<div style="font-size: small;"> 192.168.1.10 LAN 08-57-00-00-20-12 </div>	<div style="font-size: small;"> ↑ 2.0 KB/s ↓ 0 B/s </div>	3 MB	<input checked="" type="checkbox"/>	<div style="font-size: small;"> 4 hours 2 h 0 min Remaining </div>

Done!

You can now enjoy playing games without lag on your computer for the next 4 hours.

4.9. Security

This function allows you to protect your home network from cyber attacks and unauthorized users by implementing these network security functions.

4.9.1. Firewall

The SPI (Stateful Packet Inspection) Firewall protects the router from cyber attacks and validate the traffic that is passing through the router based on the protocol. This function is enabled by default.

1. Visit <http://mwlogin.net>, and log in with your Mercusys ID or the password you set for the router.
2. Go to **Advanced > Security > Firewall**, and configure the parameters as you need. It's recommended to keep the default settings.

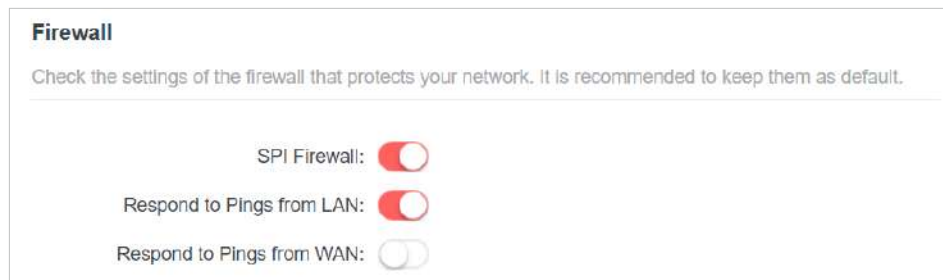

4.9.2. Access Control

Access Control is used to block or allow specific client devices to access your network (via wired or wireless) based on a list of blocked devices (Blacklist) or a list of allowed devices (Whitelist).

I want to:

Block or allow specific client devices to access my network (via wired or wireless).

How can I do that?

1. Visit <http://mwlogin.net>, and log in with your Mercusys ID or the password you set for the router.
2. Go to **Advanced > Security > Access Control**.
3. Select the access mode to either block (recommended) or allow the device(s) in the list.

To block specific device(s):

- 1) Select **Blacklist** and click **SAVE**.

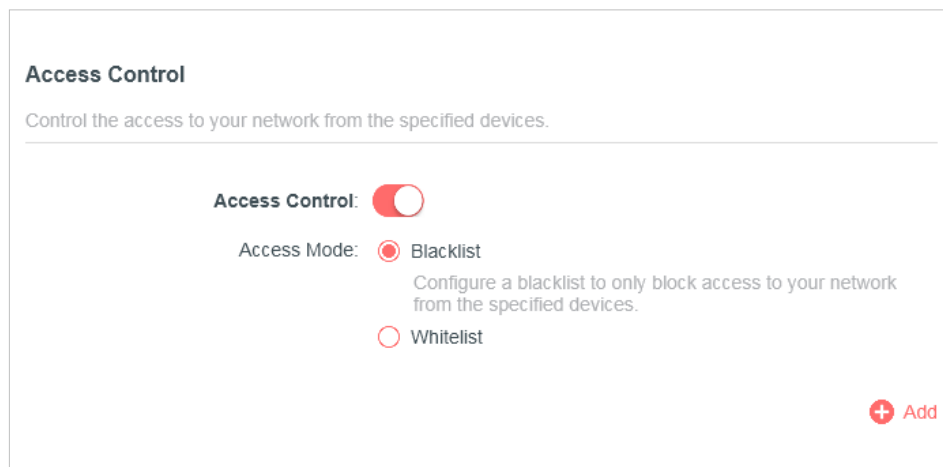

- 2) Click **Add** and select devices you want to be blocked. You can see the devices have been added to the blacklist.



Device Type	Device Name	MAC Address	Modify
	XXXXXXXX-XXXX	00-11-22-33-44-55	
	XXXXXXXX-XXXX	70-47-E9-E7-22-44	

To allow specific device(s):

- 1) Select **Whitelist** and click **SAVE**.

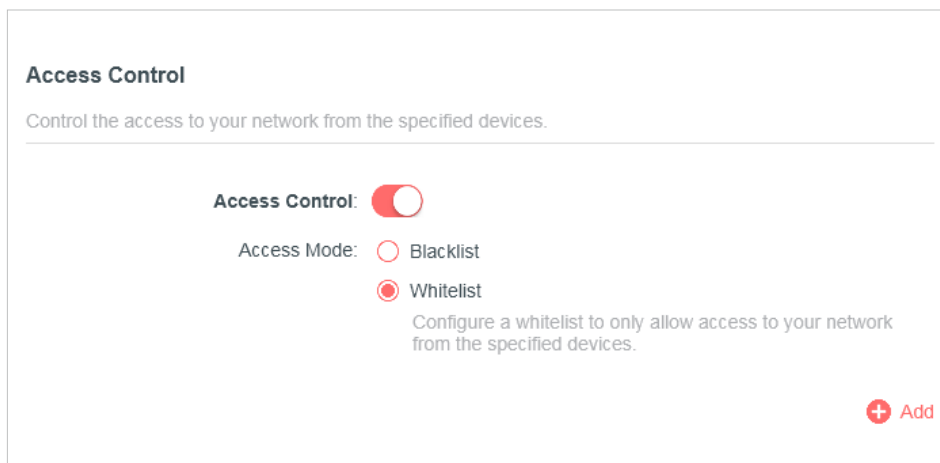

Access Control

Control the access to your network from the specified devices.

Access Control:

Access Mode: Blacklist Whitelist

Configure a whitelist to only allow access to your network from the specified devices.

Add

- 2) Add devices to the whitelist.

- **Add connected devices**

Click **Select From Device List** and select the devices you want to be allowed.

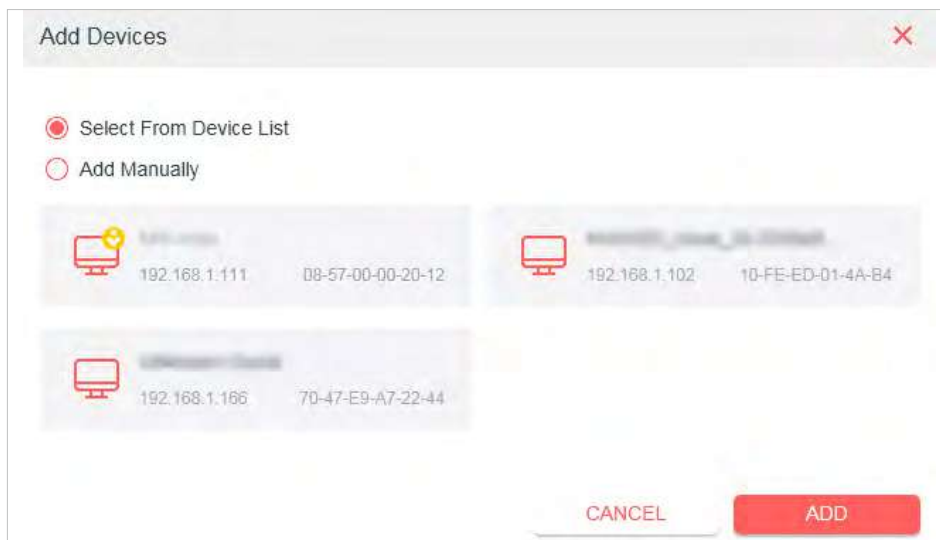

Add Devices

Select From Device List Add Manually

 192.168.1.111 08-57-00-00-20-12

 192.168.1.102 10-FE-ED-01-4A-B4

 192.168.1.166 70-47-E9-A7-22-44

CANCEL **ADD**

- **Add unconnected devices**

Click **Add Manually** and enter the **Device Name** and **MAC Address** of the device you want to be allowed.

Done!

Now you can block or allow specific client devices to access your network (via wired or wireless) using the **Blacklist** or **Whitelist**.

4.9.3. IP & MAC Binding

IP & MAC Binding, namely, ARP (Address Resolution Protocol) Binding, is used to bind network device's IP address to its MAC address. This will prevent ARP Spoofing and other ARP attacks by denying network access to a device with matching IP address in the Binding list, but unrecognized MAC address.

I want to:

Prevent ARP spoofing and ARP attacks.

How can I do that?

1. Visit <http://mwlogin.net>, and log in with your Mercusys ID or the password you set for the router.
2. Go to **Advanced > Security > IP & MAC Binding**.
3. Enable **IP & MAC Binding** and click **SAVE**.

4. Bind your device(s) according to your need.



To bind the connected device(s):

Locate the **ARP List** section and enable Bind to bind the IP and MAC addresses of a specific device.

ARP List

Bind or unbind the MAC and IP addresses of currently connected devices.

 Refresh

Device Name	MAC Address	IP Address	Bind	Modify
Unknown	08-57-00-00-20-12	192.168.1.111	<input type="checkbox"/>	
Unknown2	08-57-00-00-20-13	192.168.1.114	<input type="checkbox"/>	

To add a binding entry:

- 1) Click **Add** in the **Binding List** section.
- 2) Click **VIEW CONNECTED DEVICES** and select the device you want to bind. Or enter the **MAC Address** and **IP Address** that you want to bind.
- 3) Click **ADD**.

Add Binding Entry
✕

MAC Address:

VIEW CONNECTED DEVICES

IP Address:

CANCEL
ADD

4.9.4. ALG

You can view ALG (Application Layer Gateway) settings at **Advanced > Security > ALG**. It is recommended to keep them as default.

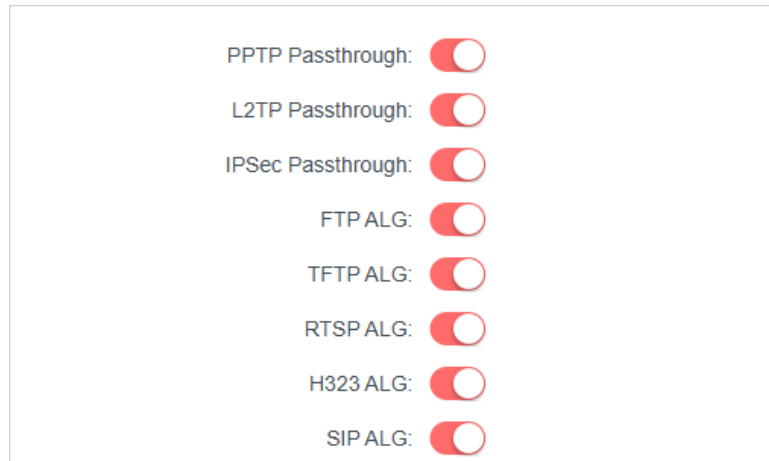

4. 10. IPv6

This function allows you to set up an IPv6 internet connection using the information provided by your ISP (internet service provider).

1. Visit <http://mwlogin.net>, and log in with your Mercusys ID or the password you set for the router.
2. Go to **Advanced > IPv6**.
3. Enable IPv6 and select the internet connection type provided by your ISP.
 Note: If you do not know what your internet connection type is, contact your ISP.
4. Fill in information as required by different connection types.
 - **Static IP:** Fill in blanks and save the settings.

IPv6 Internet

Set up an IPv6 internet connection using the information provided by your ISP (internet service provider).

IPv6:

Internet Connection Type:

IPv6 Address:

Default Gateway:

Primary DNS:

Secondary DNS:

MTU Size:

bytes. (The default is 1500, do not change unless necessary.)

- **Dynamic IP(SLAAC/DHCPv6):** Click **Advanced Settings** to input further information if your ISP requires. Save the settings and click **RENEW**.

IPv6 Internet

Set up an IPv6 internet connection using the information provided by your ISP (internet service provider).

IPv6:

Internet Connection Type: Dynamic IP(SLAAC/DHCPv6) ▾

IPv6 Address: ::

Primary DNS: ::

Secondary DNS: ::

RENEW

RELEASE

▶ **Advanced Settings**

- **PPPoE:** By default, the router uses the IPv4 account to connect to the IPv6 server. Click **Advanced Settings** to input further information if your ISP requires. Save the settings and click **CONNECT**.

Note: If your ISP provides two separate accounts for the IPv4 and IPv6 connections, manually enter the username and password for the IPv6 connection.

IPv6 Internet

Set up an IPv6 internet connection using the information provided by your ISP (internet service provider).

IPv6:

Internet Connection Type: PPPoE ▾

Share the same PPPoE session with IPv4

Username:

Password:

IPv6 Address: ::

▶ **Advanced Settings**

CONNECT

DISCONNECT

- **6to4 Tunnel:** An IPv4 internet connection type is a prerequisite for this connection type. Please manually set up your internet connection first. Click **Advanced Settings** to input further information if your ISP requires. Save the settings and click **CONNECT**.

IPv6 Internet

Set up an IPv6 internet connection using the information provided by your ISP (internet service provider).

IPv6:

Internet Connection Type: 6to4 Tunnel

IPv4 Address: 0.0.0.0

IPv4 Subnet Mask: 0.0.0.0

IPv4 Default Gateway: 0.0.0.0

TUNNEL ADDRESS: ::

[▶ Advanced Settings](#)

CONNECT

DISCONNECT

- **Pass-Through (Bridge):** Save the settings. No configuration is required.

IPv6 Internet

Set up an IPv6 internet connection using the information provided by your ISP (internet service provider).

IPv6:

Internet Connection Type: Pass-Through (Bridge)

5. Configure LAN ports. Windows users are recommended to choose from the first two types.

IPv6 LAN

Configure the LAN IPv6 address of the router and set the configuration type to assign IPv6 addresses to the clients.

Assigned Type: DHCPv6
 SLAAC+Stateless DHCP
 SLAAC+RDNSS

Address: FE80::2EB:D8FF:FE4A:CAF2/64

6. Locate the **MAC Clone** section. You can choose an option as needed (enter the MAC address if **Use Custom MAC Address** is selected), and click **SAVE**.

MAC Clone

Router MAC Address:

00 - EB - D8 - 99 - CE - E1

4. 11. System

4. 11. 1. Firmware Update

Mercusys is dedicated to improving and enriching the product features, giving you a better network experience. We will release the latest firmware at Mercusys official website www.mercusys.com. You can download the latest firmware file from the Support page of our website and update the firmware to the latest version.

Note:

- Back up your router's configurations before firmware update.
- Do NOT turn off the router during the firmware update.

1. Visit <http://mwlogin.net>, and log in with your Mercusys ID or the password you set for the router.
2. Go to **Advanced > System > Firmware Update**.
3. Choose a way to update your firmware.

- **Auto Update**

Enable **Auto Update** and set the update time. The router will update firmware automatically at the specified time when new version is available.

Auto Update

Update firmware automatically when new version is available.

Auto Update:

Current Time: 2022-10-27 1:45:10 AM Settings

Update Time:

- **Online Update**

Click **CHECK FOR UPDATES** to see whether a new firmware is released. Click **UPDATE** if there is new firmware.

Online Update

Update firmware over the internet.

Firmware Version: XXXXXXXXXX

Hardware Version: MR-XXXXXX

CHECK FOR UPDATES

Firmware is up to date.

Online Update

Update firmware over the internet.

Firmware Version: XXXXXXXXXX

Hardware Version: MR-XXXXXX

Latest Firmware Version: XXXXXXXXXX What's New

UPDATE

- **Local Update**

- 1) Download the latest firmware file for the router from www.mercusys.com.
- 2) Click **BROWSE** to locate the downloaded firmware file, and click **UPDATE**.

4. 11. 2. Backup & Restore

The configuration settings are stored as a configuration file in the router. You can backup the configuration file in your computer for future use and restore the router to the previous settings from the backup file when needed.

1. Visit <http://mwlogin.net>, and log in with your Mercusys ID or the password you set for the router.
2. Go to **Advanced > System > Backup & Restore**.

To backup configuration settings:

Click **BACK UP** to save a copy of the current settings in your local computer. A “.bin” file of the current settings will be stored in your computer.

To restore configuration settings:

1. Click **BROWSE** to locate the backup configuration file stored in your computer, and click **RESTORE**.
2. Wait a few minutes for the restoring and rebooting.

To reset the router to factory default settings:

1. Click **FACTORY RESTORE** to reset all settings, or click **RESTORE** if you want to keep your login and cloud account information.

Note:

- We strongly recommend you back up the current configuration settings before resetting the router.
- During the resetting process, do not turn off or reset the router.

Factory Default Restore

Restore all settings to default values.

Restore all configuration settings to default values, except your login and cloud account information.

RESTORE

Restore all the configuration settings to their default values.

FACTORY RESTORE

2. Wait a few minutes for the restoring and rebooting.

4. 11. 3. Change Password

1. Visit <http://mwlogin.net>, and log in with your Mercusys ID or the password you set for the router.
2. Go to **Advanced > System > Administration**, and focus on the Change Password section.

Change Password

Change the router's local management password.

Old Password:

New Password:

Confirm New Password:

3. Enter the old password, then a new password twice (both case-sensitive). Click **SAVE**.
4. Use the new password for future logins.

4. 11. 4. Password Recovery

This feature allows you to recover the login password you set for you router in case you forget it.

1. Visit <http://mwlogin.net>, and log in with your Mercusys ID or the password you set for the router.
2. Go to **Advanced > System > Administration**, and focus on the Password Recovery section.

3. Tick the **Enable** box of **Password Recovery**.
4. Specify a **mailbox (From)** for sending the recovery letter and enter its **SMTP Server** address. Specify a **mailbox (To)** for receiving the recovery letter. If the mailbox (From) to send the recovery letter requires encryption, tick the **Enable** box of **Authentication** and enter its username and password.

Tips:

- SMTP server is available for users in most webmail systems. For example, the SMTP server address of Gmail is smtp.gmail.com.
- Generally, Authentication should be enabled if logging in to the mailbox requires a username and password.

Password Recovery

Reset local management password via preset questions and answers.

Password Recovery: Enable

From:

To:

SMTP Server:

Authentication: Enable

Username:

Password: 

5. Click **SAVE**.

To recover the login password, please visit <http://mwlogin.net>, click **Forgot Password?** on the login page and follow the instructions to set a new password.

4. 11. 5. Local Management

1. Visit <http://mwlogin.net>, and log in with your Mercusys ID or the password you set for the router.
2. Go to **Advanced > System > Administration**, and focus on the Local Management section.

- **Access the router via HTTPS and HTTP:**

Tick the **Enable** box of **Local Management via HTTPS** to access the router via HTTPS and HTTP, or keep it disabled to access the router only via HTTP.

Local Management

Access and manage the router from local network devices.

Local Management via HTTPS: Enable

Local Managers:

- **Allow all LAN connected devices to manage the router:**

Select **All Devices** for Local Managers.

Local Management

Access and manage the router from local network devices.

Local Management via HTTPS: Enable

Local Managers:

- **Allow specific devices to manage the router:**

1. Select **Specified Devices** for Local Managers and click **SAVE**.

Local Management

Access and manage the router from local network devices.

Local Management via HTTPS: Enable

Local Managers:

[+ Add Device](#)

Description	MAC Address	Operation
W	FC-AA-14-55-FB-5D	

2. Click **Add Device**.

3. Click **VIEW CONNECTED DEVICES** and select the device to manage the router from the Connected Devices list, or enter the **MAC address** of the device manually.
4. Specify a **Description** for this entry.
5. Click **SAVE**.

4. 11. 6. Remote Management

1. Visit <http://mwlogin.net>, and log in with your Mercusys ID or the password you set for the router.
2. Go to **Advanced > System > Administration**, and focus on the Remote Management section.

- **Forbid all devices to manage the router remotely:**

Do not tick the **Enable** checkbox of **Remote Management**.

- **Allow all devices to manage the router remotely:**

Remote Management

Access and manage the router over the internet.

Note: Remote Management is not supported when you are connected to the internet only via IPv6. If you want to use Remote Management, please make sure you have set up an IPv4 connection first.

Remote Management: Enable

HTTPS Port:

HTTP Port:

Web Address for Management:

Remote Managers:

1. Tick the **Enable** checkbox of **Remote Management**.
2. Keep the HTTPS and HTTP port as default settings (recommended) or enter a value between 1024 and 65535.
3. Select **All Devices** for **Remote Managers**.
4. Click **SAVE**.

Devices on the internet can log in to **https://Router's WAN IP address:port number** (such as **https://113.116.60.229:1024**) to manage the router.

Tips:

- You can find the WAN IP address of the router on **Network Map > Internet**.
- The router's WAN IP is usually a dynamic IP. Please refer to **Dynamic DNS** if you want to log in to the router through a domain name.
- **Allow a specific device to manage the router remotely:**

Remote Management

Access and manage the router over the internet.

Note: Remote Management is not supported when you are connected to the internet only via IPv6. If you want to use Remote Management, please make sure you have set up an IPv4 connection first.

Remote Management: Enable

HTTPS Port:

HTTP Port:

Web Address for Management:

Remote Managers:

Only this IP Address:

1. Tick the **Enable** checkbox of **Remote Management**.
2. Keep the HTTPS and HTTP port as default settings (recommended) or enter a value between 1024 and 65535.
3. Select **Specified Device** for **Remote Managers**.

- In the **Only this IP Address** field, enter the IP address of the remote device to manage the router.
- Click **SAVE**.

Devices using this WAN IP can manage the router by logging in to **<https://Router's WAN IP:port number>** (such as **<https://113.116.60.229:1024>**).

Tips: The router's WAN IP is usually a dynamic IP. Please refer to **Dynamic DNS** if you want to log in to the router through a domain name.

4. 11. 7. System Log

- Visit **<http://mwlogin.net>**, and log in with your Mercusys ID or the password you set for the router.
- Go to **Advanced > System > System Log**, and you can view the logs of the router.

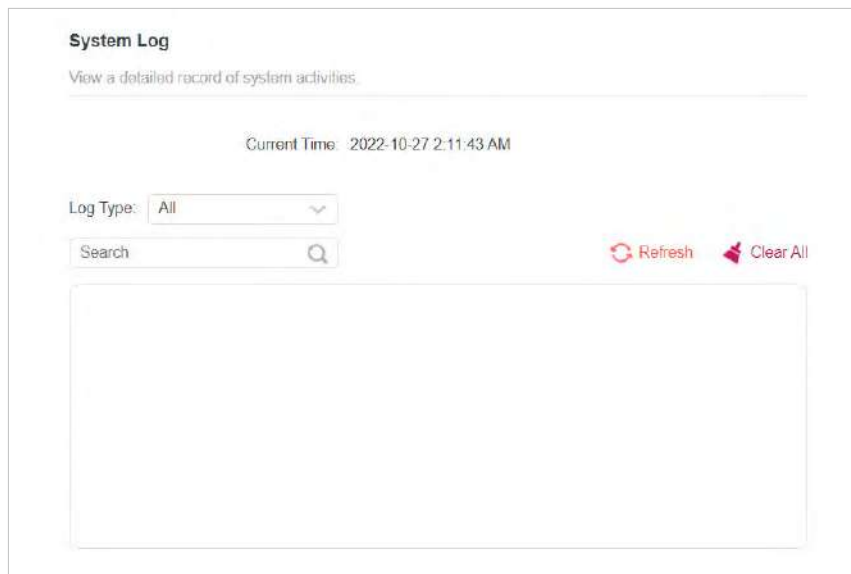

- Click **SAVE TO LOCAL** to save the system logs to a local disk.

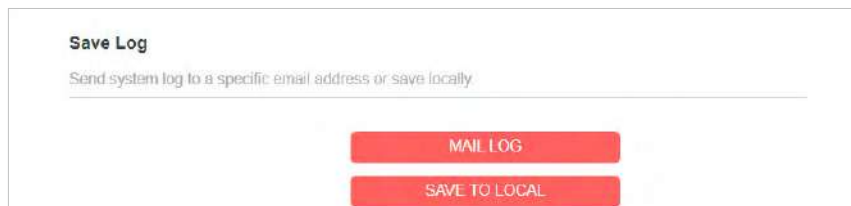

- If you want to send the system log to your mailbox, click **MAIL LOG** and configure the mail settings.

Mail Log

Set your mail information below.

Email From:

Require Password

Username:

Email Password:

SMTP Server:

Email To:

Mail Log Automatically

Frequency:

Mail Time: :

- **Email From:** Enter the email address used for sending the system log.
- **Require Password:** Generally, Require Password should be selected if the login of the mailbox requires username and password.
- **Username:** Enter the email address used for sending the system log.
- **Email Password:** Enter the password to login the sender's email address.
- **SMTP Server:** Enter the SMTP server address. SMTP server is available for users in most webmail systems. For example, the SMTP server address of Hotmail is smtp-mail.outlook.com.
- **Email To:** Enter the recipient's email address, which can be the same as or different from the sender's email address.
- **Mail Log Automatically:** If selected, the router will automatically send the system log to the designated email address.
- **Frequency:** Specify how often the recipient will receive the system log.
- **Mail Time:** Specify when the recipient will receive the system log.

4.11.8. Diagnostics

Diagnostic is used to test the connectivity between the router and the host or other network devices.

1. Visit <http://mwlogin.net>, and log in with your Mercusys ID or the password you set for the router.
2. Go to **Advanced > System > Diagnostics**.

Diagnostics

Troubleshoot network connectivity problems.

Diagnostics Tools:

IP Address/Domain Name:

Ping Packet Number:

Ping Packet Size: Bytes

START

3. Enter the information:

- 1) Choose **Ping** or **Traceroute** as the diagnostic tool to test the connectivity.
 - **Ping** is used to test the connectivity between the router and the tested host, and measure the round-trip time.
 - **Traceroute** is used to display the route (path) your router has passed to reach the tested host, and measure transit delays of packets across an Internet Protocol network.
- 2) Enter the **IP Address** or **Domain Name** of the tested host.
- 3) Modify the **Ping Count** number and the **Ping Packet Size**. It's recommended to keep the default value.
- 4) If you have chosen **Traceroute**, you can modify the **Traceroute Max TTL**. It's recommended to keep the default value.

4. Click **START** to begin the diagnostics.

The figure below indicates the proper connection between the router and the Yahoo server (www.Yahoo.com) tested through **Ping**.

```

Finding host yahoo.com by DNS server (1 of 2).
Pinging yahoo.com [98.138.219.231] with 64 bytes of data:
Reply from 98.138.219.231: bytes=64 time=233ms TTL=48 (seq=0).
Reply from 98.138.219.231: bytes=64 time=233ms TTL=48 (seq=1).
Reply from 98.138.219.231: bytes=64 time=233ms TTL=48 (seq=2).
Reply from 98.138.219.231: bytes=64 time=233ms TTL=48 (seq=3).
Ping statistics for 98.138.219.231:
    Packets: Sent = 4, Received = 4, Lost = 0 (0% loss),
    Approximate round trip times in milli-seconds:
        Minimum = 233ms, Maximum = 233ms, Average = 233ms

```

The figure below indicates the proper connection between the router and the Yahoo server (www.Yahoo.com) tested through **Traceroute**.

```

Finding host yahoo.com by DNS server (1 of 2).
Tracing route to yahoo.com [72.30.35.10]
over a maximum of 20 hops:
 0 0 ms 0 ms 0 ms 10.0.0.1
 1 1 ms 1 ms 1 ms 116.24.64.1
 2 1 ms 1 ms 1 ms 202.105.155.185
 3 1 ms 1 ms 1 ms 183.56.65.2
 4 * 1 ms * 202.97.94.150
 5 16 ms 16 ms 16 ms 202.97.94.94
 6 150 ms 150 ms 150 ms 202.97.27.242
 7 166 ms 166 ms 166 ms 202.97.50.74
 8 150 ms 150 ms 150 ms 4.53.210.145

```

4. 11. 9. Time

This function allows you to set the time manually or to configure automatic time synchronization. The router can automatically update the time from an NTP server via the internet.

1. Visit <http://mwlogin.net>, and log in with your Mercusys ID or the password you set for the router.
2. Go to **Advanced > System > Time & Language**.

- **To set System Time:**

1. In the **System Time** section, select the way in which the router gets its time: **Get from Internet, Get from Managing Device, Manually**.
2. Select your local **Time Zone**.
3. Enter the address or domain of the **NTP Server I** or **NTP Server II**.
4. Click **SAVE**.

- **To set up Daylight Saving Time:**

1. In the **Daylight Saving Time** section, tick the **Enable** box.

2. Select the start time from the drop-down list in the **Start** fields.
3. Select the end time from the drop-down list in the **End** fields.
4. Click **SAVE**.

Note:

This setting will be used for some time-based functions such as firewall. You must specify your time zone once you log in to the router successfully; otherwise, time-based functions will not take effect.

4. 11. 10. Language

This function allows you to set the language for the system.

1. Visit <http://mwlogin.net>, and log in with your Mercusys ID or the password you set for the router.
2. Go to **Advanced > System > Time & Language**.

3. In the **Language** section, choose your desired language.
4. Click **SAVE**.

4. 11. 11. Reboot

Some settings of the router will take effect only after rebooting, and the system will reboot automatically. You can also reboot the router to clear cache and enhance running performance.

1. Visit <http://mwlogin.net>, and log in with your Mercusys ID or the password you set for the router.
2. Go to **Advanced > System > Reboot**, and you can restart your router.

- **To reboot the router manually:**

Click **REBOOT**, and wait a few minutes for the router to reboot.

Reboot

Reboot to clear cache and enhance running performance.

REBOOT

- **To set the router to reboot regularly:**

1. Tick the **Enable** box of **Reboot Schedule**.
2. Specify the **Reboot Time** when the router reboots and **Repeat** to decide how often it reboots.
3. Click **SAVE**.

Reboot Schedule

Set when and how often the router reboots automatically.

Reboot Schedule: Enable

Note: Make sure **Time Settings** are correct before using this function.

Current Time: 2018-07-20 09:00:00

Reboot Time: 02 : 00

Repeat: Every Day

4. 11. 12. LED Control

The LED of the router indicates its activities and status. You can enable the **Night Mode** feature to specify a time period during which the LED is off.

1. Visit <http://mwlogin.net>, and log in with your Mercusys ID or the password you set for the router.
2. Go to **Advanced > System > LED Control**.
3. Enable **Night Mode**.

LED Control
Turn the router's LEDs on or off.

LED Control:

Night Mode
Set a time period when the LEDs will be off automatically.

Night Mode: Enable

Note: Make sure **Time Settings** are correct before using this function.

Current Time: 2022-10-27 2:29:39 AM

LED Off From: 10 : 00 PM
To: 7 : 00 AM (next day)

4. Specify the LED off time, and the LED will be off during this period every day.

Note: The effective LED off time is based on the time of the router. You can go to **Advanced > System > Time** to modify the time.

5. Click **SAVE**.

4. 11. 13. CWMP Settings

CPE WAN Management Protocol (also called TR-069) allows Auto-Configuration Server (ACS) to perform auto-configuration, provision, connection, and diagnostics to this device. You may configure this function under your ISP's instructions.

1. Visit <http://mwlogin.net>, and log in with your Mercusys ID or the password you set for the router.
2. Go to **Advanced > System > CWMP Settings**.
3. Configure the parameters according to your ISP's instructions, and click **SAVE**.

CWMP:
 Inform:
 Inform Interval:
 Data Model:
 WAN IP Address:
 ACS URL:
 ACS Username:
 ACS Password:
 Interface used by TR-069 client:
 Connection Require Authentication
 Username:
 Password:
 Path:
 Port:
 URL:
 Stun:
 STUN Maximum Keep Alive Period: (Seconds)
 STUN Minimum Keep Alive Period: (Seconds)
 STUN Server Address:
 STUN Server Port:
 STUN Server Username:
 STUN Server Password:

- **CWMP** - Toggle on to enable the CWMP function.
- **Inform** - Enable to send an inform message to the ACS periodically.
- **Inform Interval** - Enter the time interval when the Inform message will be sent to the ACS. The default value is 3600 seconds.
- **Data Model** - Select under your ISP's instructions the data model according to which the inform message will be sent to the ACS.
- **WAN IP Address** - Displays the WAN IP Address of the router.
- **ACS URL** - Enter the web address of the ACS provided by your ISP.
- **ACS Username/Password** - Enter the username/password to log in to the ACS server.

- **Interface used by TR-069 client** - Select the interface to be used by the TR-069 client.
- **Connection Require Authentication** - Check this box to enable authentication for the connection requests.
- **Username/Password** - Enter the username/password for the ACS server to log in to the router.
- **Path** - Enter the path for the ACS server to log in to the router.
- **Port** - Enter the port that connects to the ACS server.
- **URL** - Enter the URL that connects to the ACS server.
- **Stun** - Enable or disable the STUN (Simple Traversal of UDP through NAT) function.
- **STUN Maximum / Minimum Keep Alive Period** - Enter the minimum/maximum time to maintain NAT binding.
- **STUN Server Address** - Enter the STUN server address provided by your ISP.
- **STUN Server Port** - Enter the STUN server port number provided by your ISP.
- **STUN Server Username/Password** - Enter the username/password to log in to the STUN server.

Chapter 5. Configure the Router in Access Point Mode

This chapter presents how to configure the various features of the router working as an access point.

It contains the following sections:

- **Operation Mode**
- **Quick Setup**
- **Firmware Update**
- **Backup & Restore**
- **Administration**
- **System Log**
- **Diagnostics**
- **Time**
- **Language**
- **Reboot**
- **LED Control**

5.1. Operation Mode

1. Visit <http://mwlogin.net>, and log in with the password you set for the router.
2. Go to **System > Operation Mode**.
3. Select the working mode as needed and click **SAVE**.

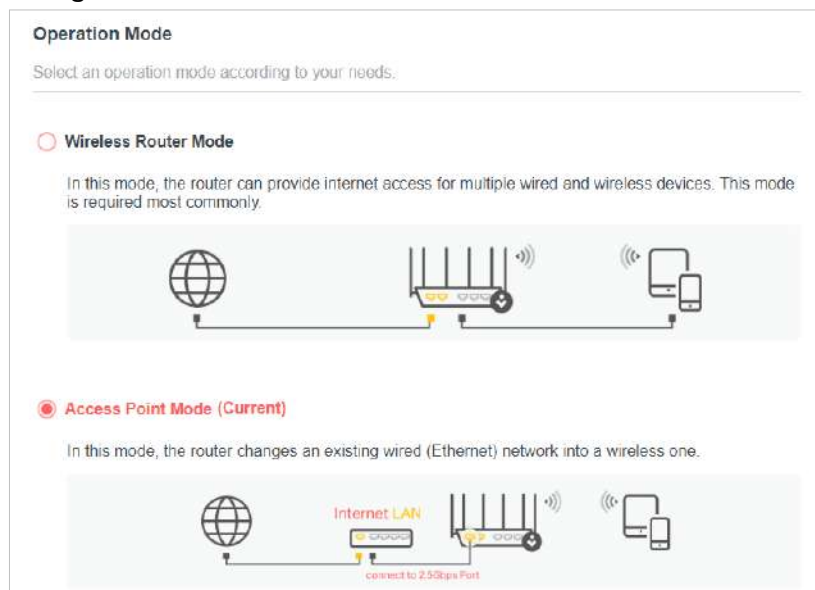

5.2. Quick Setup

1. Visit <http://mwlogin.net>, and log in with the password you set for the router.
2. Go to **System > Quick Setup**.
3. Follow the step-by-step instructions to complete the setup.

Personalize Wireless Settings
Personalize your wireless network name and password.

Smart Connect: Enable ?

2.4GHz: Enable

Network Name (SSID):

Password:

Set Each Band Separately

5GHz: Enable

Network Name (SSID):

Password:

SAVE

5.3. Firmware Update

Mercusys is dedicated to improving and enriching the product features, giving you a better network experience. We will release the latest firmware at Mercusys official website www.mercusys.com. You can download the latest firmware file from the Support page of our website and update the firmware to the latest version.

Note:

- Back up your router's configurations before firmware update.
- Do NOT turn off the router during the firmware update.

1. Visit <http://mwlogin.net>, and log in with the password you set for the router.
2. Go to **System > Firmware Update**.
3. Choose a way to update your firmware.

• Online Update

Click **CHECK FOR UPDATES** to see whether a new firmware is released. Click **UPDATE** if there is new firmware.

Online Update

Update firmware over the internet.

Firmware Version:

Hardware Version: MR

Firmware is up to date.

Online Update

Update firmware over the internet.

Firmware Version:

Hardware Version: MR

Latest Firmware Version: [What's New](#)

• Local Update

- 1) Download the latest firmware file for the router from www.mercusys.com.
- 2) Click **BROWSE** to locate the downloaded firmware file, and click **UPDATE**.

Local Update

Update firmware from a local file.

Firmware Version:

Hardware Version: MR

New Firmware File:

5.4. Backup & Restore

The configuration settings are stored as a configuration file in the router. You can backup the configuration file in your computer for future use and restore the router to the previous settings from the backup file when needed.

1. Visit <http://mwlogin.net>, and log in with the password you set for the router.

2. Go to **System > Backup & Restore**.

To backup configuration settings:

Click **BACK UP** to save a copy of the current settings in your local computer. A ".bin" file of the current settings will be stored in your computer.

Backup
Save current router settings to a file.

BACK UP

To restore configuration settings:

1. Click **BROWSE** to locate the backup configuration file stored in your computer, and click **RESTORE**.
2. Wait a few minutes for the restoring and rebooting.

Restore
Restore settings from a backup file.

File:

BROWSE

RESTORE

To reset the router to factory default settings:

1. Click **FACTORY RESTORE** to reset all settings, or click **RESTORE** if you want to keep your login and cloud account information.

Note:

- We strongly recommend you back up the current configuration settings before resetting the router.
- During the resetting process, do not turn off or reset the router.

Factory Default Restore
Restore all settings to default values.

Restore all configuration settings to default values, except your login and cloud account information.

RESTORE

Restore all the configuration settings to their default values.

FACTORY RESTORE

2. Wait a few minutes for the restoring and rebooting.

5.5. Administration

5.5.1. Change Password

1. Visit <http://mwlogin.net>, and log in with the password you set for the router.
2. Go to **System > Administration**, and focus on the Change Password section.

Change Password

Change the router's local management password.

Old Password: 

New Password: 

Confirm New Password: 

3. Enter the old password, then a new password twice (both case-sensitive). Click **SAVE**.
4. Use the new password for future logins.

5.5.2. Password Recovery

This feature allows you to recover the login password you set for your router in case you forget it.

1. Visit <http://mwlogin.net>, and log in with your Mercusys ID or the password you set for the router.
2. Go to **System > Administration**, and focus on the Password Recovery section.
3. Tick the **Enable** box of **Password Recovery**.
4. Specify a **mailbox (From)** for sending the recovery letter and enter its **SMTP Server** address. Specify a **mailbox (To)** for receiving the recovery letter. If the mailbox (From) to send the recovery letter requires encryption, Tick the **Enable** box of **Authentication** and enter its username and password.

Tips:

- SMTP server is available for users in most webmail systems. For example, the SMTP server address of Gmail is smtp.gmail.com.
- Generally, Authentication should be enabled if logging in to the mailbox requires a username and password.

Password Recovery

Reset local management password via preset questions and answers.

Password Recovery: Enable

From:

To:

SMTP Server:

Authentication: Enable

Username:

Password:

5. Click **SAVE**.

To recover the login password, please visit <http://mwlogin.net>, click **Forgot Password?** on the login page and follow the instructions to set a new password.

5.5.3. Local Management

1. Visit <http://mwlogin.net>, and log in with the password you set for the router.
2. Go to **System > Administration**, and focus on the Local Management section.

➤ **Access the router via HTTPS and HTTP:**

Tick the **Enable** box of **Local Management via HTTPS** to access the router via HTTPS and HTTP, or keep it disabled to access the router only via HTTP.

Local Management

Access and manage the router from local network devices.

Local Management via HTTPS: Enable

Local Managers:

➤ **Allow all LAN connected devices to manage the router:**

Select **All Devices** for Local Managers.

Local Management

Access and manage the router from local network devices.

Local Management via HTTPS: Enable

Local Managers:

➤ **Allow specific devices to manage the router:**

1. Select **Specified Devices** for Local Managers and click **SAVE**.

Local Management
Access and manage the router from local network devices.

Local Management via HTTPS: Enable

Local Managers: Specified Devices

[+ Add Device](#)

Description	MAC Address	Operation
W...	FC-AA-14-55-FB-5D	

2. Click **Add Device**.

Add Device ✕

Description:

[VIEW CONNECTED DEVICES](#)

MAC Address:

[CANCEL](#) [SAVE](#)

3. Click **VIEW CONNECTED DEVICES** and select the device to manage the router from the Connected Devices list, or enter the **MAC address** of the device manually.

4. Specify a **Description** for this entry.

5. Click **SAVE**.

5.6. System Log

1. Visit <http://mwlogin.net>, and log in with the password you set for the router.

2. Go to **System > System Log**, and you can view the logs of the router.



System Log

View a detailed record of system activities.

Current Time: 2022-10-27 2:11:43 AM

Log Type: All

Search

 Refresh  Clear All

3. Click **SAVE TO LOCAL** to save the system logs to a local disk.

Save Log

Send system log to a specific email address or save locally.

4. If you want to send the system log to your mailbox, click **MAIL LOG** and configure the mail settings.

Mail Log ✕

Set your mail information below.

Email From:

Require Password

Username:

Email Password:

SMTP Server:

Email To:

Mail Log Automatically

Frequency: Every Day

Mail Time: 00 : 00

- **Email From:** Enter the email address used for sending the system log.

- **Require Password:** Generally, Require Password should be selected if the login of the mailbox requires username and password.
- **Username:** Enter the email address used for sending the system log.
- **Email Password:** Enter the password to login the sender's email address.
- **SMTP Server:** Enter the SMTP server address. SMTP server is available for users in most webmail systems. For example, the SMTP server address of Hotmail is smtp-mail.outlook.com.
- **Email To:** Enter the recipient's email address, which can be the same as or different from the sender's email address.
- **Mail Log Automatically:** If selected, the router will automatically send the system log to the designated email address.
- **Frequency:** Specify how often the recipient will receive the system log.
- **Mail Time:** Specify when the recipient will receive the system log.

5.7. Diagnostics

Diagnostic is used to test the connectivity between the router and the host or other network devices.

1. Visit <http://mwlogin.net>, and log in with the password you set for the router.
2. Go to **System > Diagnostics**.

3. Enter the information:
 - 1) Choose **Ping** or **Traceroute** as the diagnostic tool to test the connectivity.
 - **Ping** is used to test the connectivity between the router and the tested host, and measure the round-trip time.
 - **Traceroute** is used to display the route (path) your router has passed to reach the tested host, and measure transit delays of packets across an Internet Protocol network.
 - 2) Enter the **IP Address** or **Domain Name** of the tested host.

- 3) Modify the **Ping Count** number and the **Ping Packet Size**. It's recommended to keep the default value.
- 4) If you have chosen **Traceroute**, you can modify the **Traceroute Max TTL**. It's recommended to keep the default value.

4. Click **START** to begin the diagnostics.

The figure below indicates the proper connection between the router and the Yahoo server (www.Yahoo.com) tested through **Ping**.

```
Finding host yahoo.com by DNS server (1 of 2).
Pinging yahoo.com [98.138.219.231] with 64 bytes of data:
Reply from 98.138.219.231: bytes=64 time=233ms TTL=48 (seq=0).
Reply from 98.138.219.231: bytes=64 time=233ms TTL=48 (seq=1).
Reply from 98.138.219.231: bytes=64 time=233ms TTL=48 (seq=2).
Reply from 98.138.219.231: bytes=64 time=233ms TTL=48 (seq=3).
Ping statistics for 98.138.219.231:
Packets: Sent = 4, Received = 4, Lost = 0 (0% loss).
Approximate round trip times in milli-seconds:
Minimum = 233ms, Maximum = 233ms, Average = 233ms
```

The figure below indicates the proper connection between the router and the Yahoo server (www.Yahoo.com) tested through **Traceroute**.

```
Finding host yahoo.com by DNS server (1 of 2).
Tracing route to yahoo.com [72.30.35.10]
over a maximum of 30 hops:
 0 1 ms 1 ms 1 ms 10.0.0.1
 1 1 ms 1 ms 1 ms 116.24.64.1
 2 1 ms 1 ms 1 ms 202.105.155.185
 3 1 ms 1 ms 1 ms 183.56.65.2
 4 * 1 ms * 202.97.94.150
 5 16 ms 16 ms 16 ms 202.97.94.94
 6 150 ms 150 ms 150 ms 202.97.27.242
 7 166 ms 166 ms 166 ms 202.97.50.74
 8 150 ms 150 ms 150 ms 4.53.210.145
```

5.8. Time

This function allows you to set the time manually or to configure automatic time synchronization. The router can automatically update the time from an NTP server via the internet.

1. Visit <http://mwlogin.net>, and log in with the password you set for the router.
2. Go to **System > Time & Language**.

- **To set System Time:**

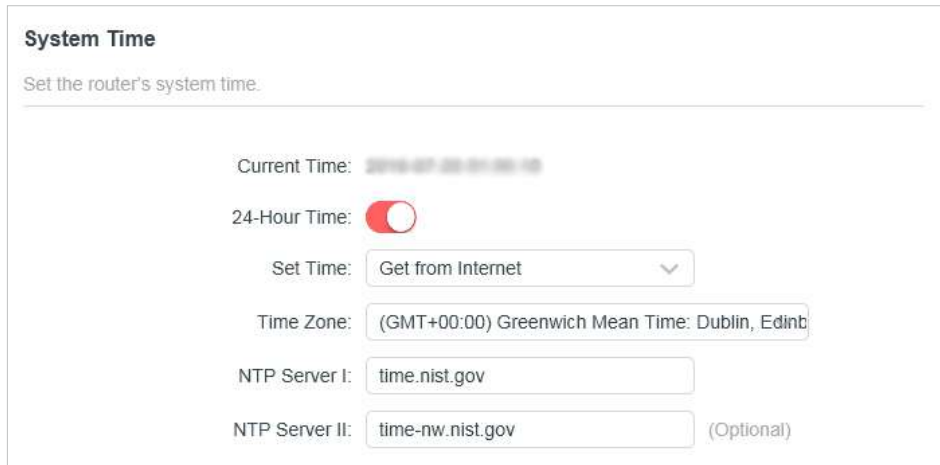

System Time
Set the router's system time.

Current Time: 2020-07-22 09:00:00

24-Hour Time:

Set Time: Get from Internet

Time Zone: (GMT+00:00) Greenwich Mean Time: Dublin, Edinb

NTP Server I: time.nist.gov

NTP Server II: time-nw.nist.gov (Optional)

1. In the **System Time** section, select the way in which the router gets its time: **Get from Internet, Get from Managing Device, Manually**.
2. Select your local **Time Zone**.
3. Enter the address or domain of the **NTP Server I** or **NTP Server II**.
4. Click **SAVE**.

• **To set up Daylight Saving Time:**

1. In the **Daylight Saving Time** section, tick the **Enable** box.

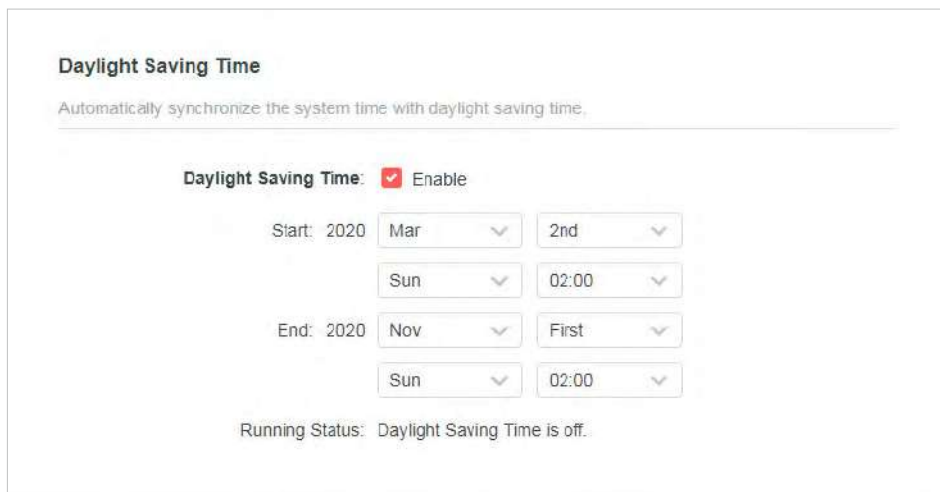

Daylight Saving Time
Automatically synchronize the system time with daylight saving time.

Daylight Saving Time: Enable

Start: 2020 Mar 2nd 02:00 Sun

End: 2020 Nov First 02:00 Sun

Running Status: Daylight Saving Time is off.

2. Select the start time from the drop-down list in the **Start** fields.
3. Select the end time from the drop-down list in the **End** fields.
4. Click **SAVE**.

Note:

This setting will be used for some time-based functions such as firewall. You must specify your time zone once you log in to the router successfully; otherwise, time-based functions will not take effect.

5.9. Language

This function allows you to set the language for the system.

1. Visit <http://mwlogin.net>, and log in with the password you set for the router.
2. Go to **System > Time & Language**.



3. In the **Language** section, choose your desired language.
4. Click **SAVE**.

5.10. Reboot

Some settings of the router will take effect only after rebooting, and the system will reboot automatically. You can also reboot the router to clear cache and enhance running performance.

1. Visit <http://mwlogin.net>, and log in with the password you set for the router.
2. Go to **System > Reboot**, and you can restart your router.

- **To reboot the router manually:**

Click **REBOOT**, and wait a few minutes for the router to reboot.

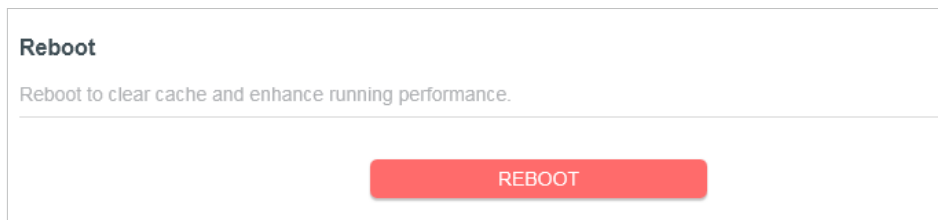

- **To set the router to reboot regularly:**

1. Tick the **Enable** box of **Reboot Schedule**.
2. Specify the **Reboot Time** when the router reboots and **Repeat** to decide how often it reboots.
3. Click **SAVE**.

Reboot Schedule

Set when and how often the router reboots automatically.

Reboot Schedule: Enable

Note: Make sure **Time Settings** are correct before using this function.

Current Time: 2022-07-20 01:00:00

Reboot Time: 02 : 00

Repeat: Every Day

5. 11. LED Control

The LED of the router indicates its activities and status. You can enable the **Night Mode** feature to specify a time period during which the LED is off.

1. Visit <http://mwlogin.net>, and log in with the password you set for the router.
2. Go to **System > LED Control**.
3. Enable **Night Mode**.

LED Control

Turn the router's LEDs on or off.

LED Control:

Night Mode

Set a time period when the LEDs will be off automatically.

Night Mode: Enable

Note: Make sure **Time Settings** are correct before using this function.

Current Time: 2022-10-27 2:29:39 AM

LED Off From: 10 : 00 PM

To: 7 : 00 AM (next day)

4. Specify the LED off time, and the LED will be off during this period every day.
Note: The effective LED off time is based on the time of the router. You can go to **System > Time** to modify the time.
5. Click **SAVE**.

FAQ

Q1. What should I do if I forget my wireless password?

The default wireless password is printed on the bottom label of the router.

If the password has been altered, please connect your computer to the router using an Ethernet cable and follow the steps below:

1. Visit <http://mwlogin.net>, and log in with the password you set for the router.
2. Go to **Wireless** or **Advanced > Wireless > Wireless Settings** to retrieve or reset your wireless password.

Q2. What should I do if I forget my login password of the web management page?

1. Log in to the web management page of the router, click **Forgot Password**, and then follow the instructions on the page to create a password for future logins.
2. Alternatively, reset the router to its factory default settings. Then visit <http://mwlogin.net>, and create a password for future login.

Note: You'll need to reconfigure the router to surf the internet once the router is reset, and please mark down your new password for future use.

Q3. What should I do if I cannot log in to the router's web management page?

This can happen for a variety of reasons. Please try the methods below to log in again.

- Make sure the router connects to the computer correctly and the corresponding LED light up.
- Make sure the IP address of your computer is configured as **Obtain an IP address automatically** and **Obtain DNS server address automatically**.
- Make sure you enter the correct IP address to log in: <http://mwlogin.net> or **192.168.1.1**.
- Check your computer's settings:
 - 1) Go to **Start > Control Panel > Network and Internet**, and click **View network status and tasks**.
 - 2) Click **Internet Options** on the bottom left.
 - 3) Click **Connections** and select **Never dial a connection**.

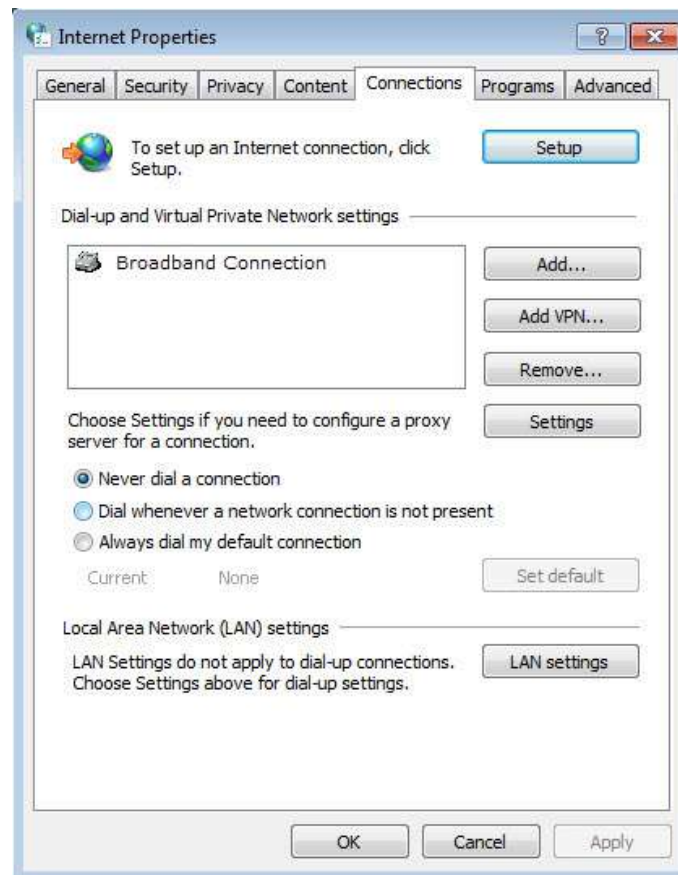

4) Click **LAN settings** and deselect the following three options, and click **OK**.



5) Go to **Advanced > Restore advanced settings**, and click **OK**.

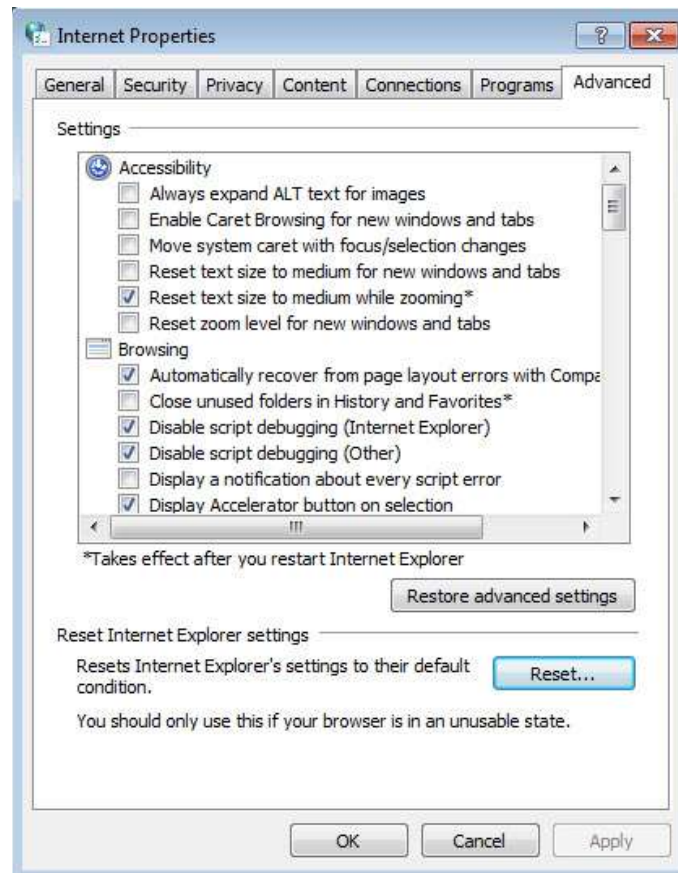

- Use another web browser or computer to log in again.
- Reset the router to factory default settings and try again. If the login still fails, please contact the technical support.

Note: You'll need to reconfigure the router to surf the internet once the router is reset.

Q4. What should I do if I cannot access the internet even though the configuration is finished?

1. Visit <http://mwlogin.net>, and log in to with the password you set for the router.
2. Go to **Advanced > Network > Status** to check the Internet status:

If IP Address is a valid one, please try the methods below and try again:

- Your computer might not recognize any DNS server addresses, please manually configure DNS server.
 - 1) Go to **Advanced > Network > DHCP Server**.
 - 2) Enter 8.8.8.8 as Primary DNS, and click **Save**.

Tips: 8.8.8.8 is a safe and public DNS server operated by Google.

- Restart the modem and the router.
 - 1) Power off your modem and the router, and leave them off for 1 minute.
 - 2) Power on your modem first, and wait about 2 minutes.
 - 3) Power on the router, and wait another 1 or 2 minutes and check the Internet access.
- Reset the router to factory default settings and reconfigure the router.
- Upgrade the firmware of the router.
- Check the TCP/IP settings on the particular device if all other devices can get internet from the router.

If the IP Address is 0.0.0.0, please try the methods below and try again:

- Make sure the physical connection between the router and the modem is proper.
- Clone the MAC address of your computer.
 - 1) Visit <http://mwlogin.net>, and log in with the username and password you set for the router.
 - 2) Go to **Advanced > Network > Internet**, select **Clone Current Device MAC** and click **SAVE**.

Tips:

- Some ISP will register the MAC address of your computer when you access the Internet for the first time through their Cable modem, if you add a router into your network to share your Internet connection, the ISP will not accept it as the MAC address is changed, so we need to clone your computer's MAC address to the router.
- The MAC addresses of a computer in wired connection and wireless connection are different.

- Modify the LAN IP address of the router.

Note:

Mercusys routers use 192.168.1.1 as their default LAN IP address. It may conflict with the IP range of your existent ADSL modem/router. If so, the router is not able to communicate with your modem and cause you can't access the Internet. To resolve this problem, we need to change the LAN IP address of the router to avoid such conflict, for example, 192.168.2.1.

- 1) Visit <http://mwlogin.net>, and log in with the username and password you set for the router.
- 2) Go to **Advanced > Network > LAN**.
- 3) Modify the LAN IP address as the follow picture shows. Here we take 192.168.2.1 as an example.
- 4) Click **Save**.

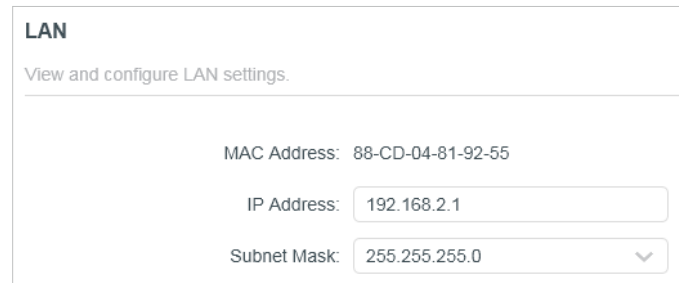

The screenshot shows a web interface for LAN settings. At the top, it says "LAN" and "View and configure LAN settings." Below this, there are three fields: "MAC Address: 88-CD-04-81-92-55", "IP Address: 192.168.2.1" (with a text input field), and "Subnet Mask: 255.255.255.0" (with a dropdown menu).

- Restart the modem and the router.
 - 1) Power off your modem and the router, and leave them off for 1 minute.
 - 2) Power on your modem first, and wait about 2 minutes.
 - 3) Power on the router, and wait another 1 or 2 minutes and check the internet access.
- Double check the Internet Connection Type.
 - 1) Confirm your Internet Connection Type, which can be learned from the ISP.
 - 2) Visit <http://mwlogin.net>, and log in with the username and password you set for the router.
 - 3) Go to **Advanced > Network > WAN**.
 - 4) Select your **Internet Connection Type** and fill in other parameters.
 - 5) Click **SAVE**.
 - 6) Restart the modem and the router.
- Please upgrade the firmware of the router.

If you've tried every method above but cannot access the internet, please contact the technical support.

Q5. What should I do if I cannot find my wireless network or I cannot connect to the wireless network?

If you fail to find any wireless network, please follow the steps below:

- Make sure the wireless function of your device is enabled if you're using a laptop with a built-in wireless adapter. You can refer to the relevant document or contact the laptop manufacturer.
- Make sure the wireless adapter driver is installed successfully and the wireless

adapter is enabled.

- **On Windows 7**

- 1) If you see the message **No connections are available**, it is usually because the wireless function is disabled or blocked somehow.
- 2) Clicking **Troubleshoot** and windows might be able to fix the problem by itself.

- **On Windows XP**

- 1) If you see the message **Windows cannot configure this wireless connection**, this is usually because windows configuration utility is disabled or you are running another wireless configuration tool to connect the wireless.
- 2) Exit the wireless configuration tool (the Mercusys Utility, for example).
- 3) Select and right click **My Computer** on Desktop, and select **Manage** to open Computer Management window.
- 4) Expand **Services and Applications > Services**, and find and locate **Wireless Zero Configuration** in the Services list on the right side.
- 5) Right click **Wireless Zero Configuration**, and then select **Properties**.
- 6) Change **Startup type** to **Automatic**, click **Start** and make sure the Service status is **Started**. And then click **OK**.

If you can find other wireless network except your own, please follow the steps below:

- Make sure your computer/device is still in the range of your router/modem. Move closer if it is currently too far away.

If you can find your wireless network but fail to connect, please follow the steps below:

- **Authenticating problem/password mismatch:**

- 1) Sometimes you will be asked to type in a PIN number when you connect to the wireless network for the first time. This PIN number is different from the Wireless Password/Network Security Key. Usually you can only find it on the label of your router.



- 2) If you cannot find the PIN or PIN failed, you may choose **Connecting using a security key** instead, and then type in the **Wireless Password/Network Security Key**.
- 3) If it continues to show note of **Network Security Key Mismatch**, it is suggested to confirm the wireless password of your wireless router.

Note: Wireless Password/Network Security Key is case sensitive.

- **Windows unable to connect to XXXX / Can not join this network / Taking longer than usual to connect to this network:**
 - Check the wireless signal strength of your network, if it is weak (1~3 bars), please move the router closer and try again.
 - Change the wireless Channel of the router to 1, 6, or 11 to reduce interference from other networks.
 - Re-install or update the driver for your wireless adapter of the computer.